

SCENIC RIDGE

***Instruction
Booklet
ST1482***

WOODLAND SCENICS



CONTENTS

Introduction	4
Layout Overview	5 & 6
Scenic Ridge Kit Contents	7
Adhesives and Special Tools	8
Low Temp Glue Foam Gun and Glue	8
Foam Tack Glue	8
Hot Wire Foam Cutter.....	9
Track	9
Begin The Layout	9
Glue Base Panels	9
Install Risers	9
Install Inclines.....	10
Finish Installing Risers	11
Overpass and Bridge	12
Install Overpass inside Tunnel.....	12
Bridge	12
Test Track and sand Risers if necessary	12
Overpass adjustment for taller trains	13
To adjust Overpass inside Tunnel	13
Tunnel Work	14
Begin by placing Plaster Cloth for tunnel area Risers	14
Lay Plaster Cloth at the Overpass and other tight spots.....	15
Lay Track-Bed inside the Tunnel area	15
Place Track and Ballast inside Tunnel	15
Place Foam Tunnel Portals.....	16
Tunnel Walls.....	17
Profile Boards	18
Back Profile Boards	18
Left Profile Boards	19
Front Profile Boards.....	19
Right Side Profile Boards	19
Trace and cut Terrain Contours and Access Panels	20
Fill corner joints where Profile Boards meet.....	20
Build Tunnel Roof.....	20
Foam Sheets (Level Areas)	21
Measure and Cut Foam Sheets to Create Flat Areas.....	21
Make Support Pilings for Foam Sheets	22
Glue Down Foam Sheets	22
Test Place Buildings.....	22
Add Risers to give the Road System a Foundation.....	22
Wiring	23

Add Plaster Cloth and Track-Bed	23
Make and place newspaper wads	23
Place Plaster Cloth	24
Test Track. Redraw track plan on Plaster Cloth covered Riser	25
Lay Track-Bed	25
Glue Down the Track	26
Make and Place Rock Castings	26
Make Rock Castings.....	26
Install Rock Castings	27
Color Rock Castings	27
Install Hydrocal Portals & Culverts	28
Paint and place Tunnel Portals	28
Paint and assemble Culverts	29
Plaster Cloth sides and front of Layout	29
Front.....	29
Sides and Back	30
Add Road System	30
Planning Roads and Paved Areas	30
Pave Areas for Town and Factory.....	30
Build Roads.....	31
Create Road Crossings.....	31
Add Sidewalks, Curbs and Foundations (optional)	32
Ballast	33
Scenery	34
Low Ground Cover	34
Color Plaster Cloth. Sprinkle Turf.....	34
Sprinkle Blended Turf	35
Accent Turf.....	35
Add Medium Ground Cover.....	35
Coarse Turf.....	35
Add Talus (Rock Debris).....	36
Add High Ground Cover	36
Assemble and Install Trees	36
Clump-Foliage.....	37
Field Grass	37
Paint the Profile Boards	38
Detail your layout	39
Add additional landscape material	39
Dry Brushing.....	39
Flyspecking with Turf.....	39
A Final Word.....	40
NTRAK	40
Products	41
Layout	42 & 43

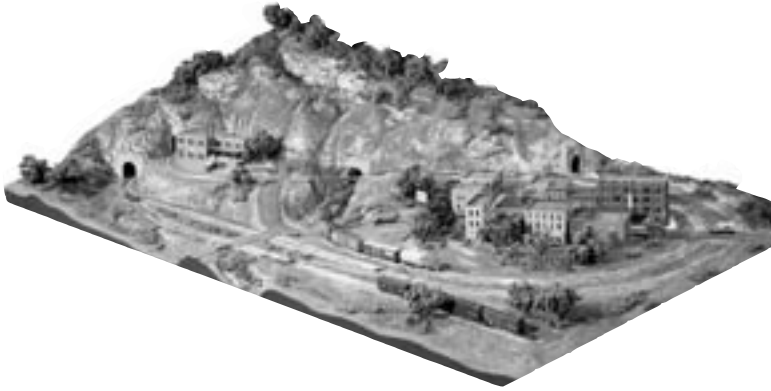

INTRODUCTION

The Scenic Ridge Lightweight Layout Kit allows you to build a 3' x 6' N scale layout, complete with inclines, mountains, creeks, tunnels, bridges, roads and landscaping. To make assembly as easy as possible the track plan has been preprinted on the base and at the back of these instructions.

Before you begin, we assume you have access to some tools and accessories that are necessary to complete the kit. Most of these materials are common household items which are listed on page 7. You will also need to purchase a Woodland Scenics Low Temp Foam Glue Gun and Glue Sticks. Another tool mentioned that can make building Scenic Ridge even easier is the Woodland Scenics Hot Wire Foam Cutter. It makes cutting and shaping the foam quick and easy. If you are interested in the Hot Wire Foam Cutter or Low Temp Foam Glue Gun, you'll find them on the Woodland Scenics SubTerrain Merchandiser at your favorite hobby store.

When you are building Scenic Ridge, keep in mind that you are allowed to make mistakes. Woodland Scenics' Systems are designed to give you plenty of room to customize your layout to match your skills. If you feel like you've made an error, you can always correct it later.

Although intended as a stand-alone layout, it can be adapted to work as an NTRAK Module or combined with layouts you build in the future.

Modules are layouts that can be joined with other layouts like pieces in a puzzle. There are both national and local clubs that supply standards and specifications for building modular layouts. The NTRAK organization is one of these clubs. For information on groups like this in your area contact one of your local model railroading organizations. Most hobby stores that carry model railroading products can help you. To convert Scenic Ridge to an NTRAK module consult the modified specifications at the back of the instructions. It is best to decide which way you will build the model before you begin.

We recommend reading through each section as you come to it so you will have an idea of what needs to be accomplished before you begin a new step.

Layout Overview

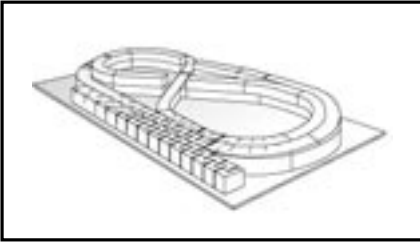

1. Risers and Inclines

Install Risers and Inclines over track plan printed on foam base.

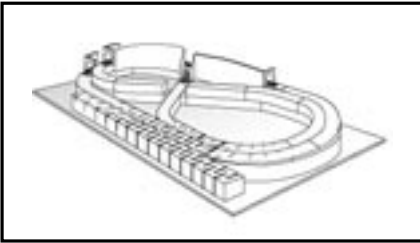

2. Tunnel Work for Risers

Add Plaster Cloth, Track-Bed, track and Ballast to the Risers that will be inside the tunnel. Install foam Tunnel Portals and tunnel walls.

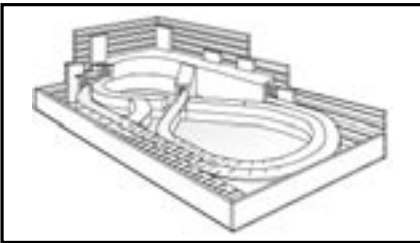

3. Profile Boards and Tunnel Roof

Place interlocking Profile Boards around perimeter of layout. Add tunnel roof.

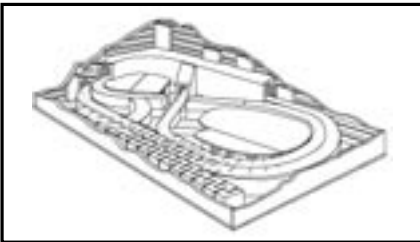

4. Foam Sheets

Cut and install Foam Sheets to enclose tunnels and to form level areas for buildings. Cut Profile Boards.

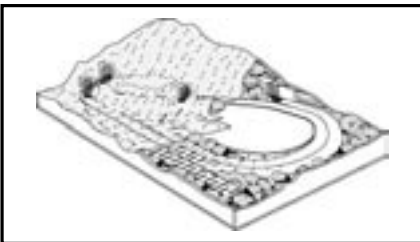

5. Add Paper Wads and Plaster Cloth

Use newspaper wads to build terrain contours and cover them with Plaster Cloth to form a hard shell.

Layout Overview

6. Lay Track-Bed

Lay Track-Bed over Plaster Cloth-covered Risers. Add track and rock faces.

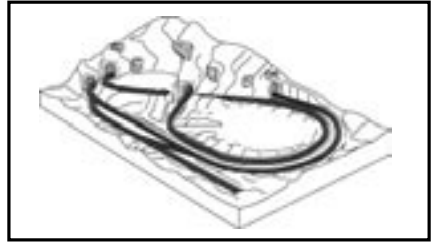

7. Apply Earth Undercoat

Install Tunnel Portals and paint Plaster Cloth with Undercoat.

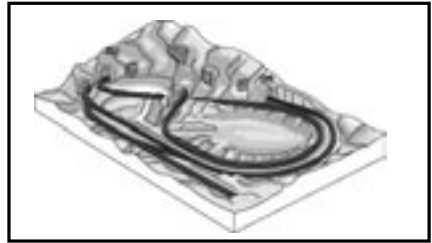

8. Add Road System

Use the Woodland Scenics' Road System to create realistic pavement and building foundations.

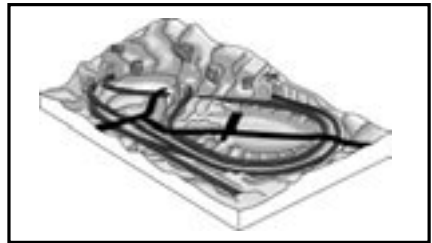

9. Begin Landscaping

Apply Woodland Scenics low ground cover over surface of layout. Ballast track.

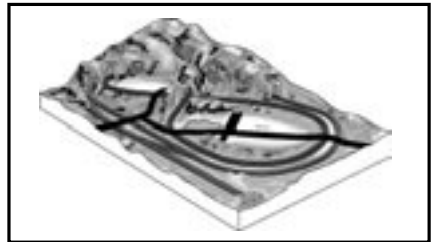

10. Finish Landscaping

Finish your layout by adding trees, bushes and grass. You can now paint the base and add your buildings and other details.

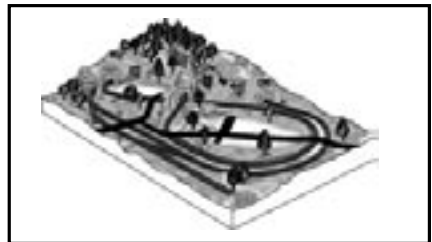

Scenic Ridge Kit Contents

Listed below are the items contained in The Scenic Ridge Kit.

<u>Description</u>	<u>Quantity</u>	<u>Description</u>	<u>Quantity</u>
Profiles 8" x 24"	10	Scenic Cement bottle	32 fl. oz.
Connectors 8" x 3"	6	Hob-e-Tac	1 fl. oz.
1/4" Sheets 1' x 2'	4	Sprayer head	1
1/2" Sheets 1' x 2'	2	Sifter Cup w/lid	1
2" Riser** pcs. 24" long	22	Foam pad	2
4% Incline** pcs. 24" long		Rock Mold (C1234)	1
(2-0"-1" and 2-1"-2")	4	Rock Mold (C1243)	1
Track-Bed** pcs. 24" long	17	Lightweight Hydrocal*	57 cu. in.
Large roll Plaster Cloth 60 sq. ft	3	Yellow/Umber/Black cups	3 cup tray
Small Plaster Cloth 5 sq. ft.	1	Earth Undercoat - clear bottle	2 fl.oz.
2" Foam Nails	75	#1 armatures	12
Asphalt Top Coat - clear bottle	2 fl. oz.	#2 armatures	12
Concrete Top Coat - clear bottle	2 fl. oz.	#3 armatures	18
Paving Tape 1/4" x 30 ft.	1 roll	Light Green Clump-Foliage**	34 cu. in.
Smooth-It	1 qt.	Med. Green Clump-Foliage**	50 cu. in.
Soil Turf	7 cu. in.	Dark Green Clump-Foliage**	16 cu. in.
Yellow Grass Turf	3 cu. in.	Cut Stone Portals	4
Earth Turf	14 cu. in.	Concrete Culverts	2
Medium Green Coarse Turf	32 cu. in.	Foam Tack Glue	8 fl. oz.
Burnt Grass Turf	7 cu. in.	1/2" x 2' x 3' foam base panels	3
Green Blend Turf	64 cu. in.	Black paint	8 fl. oz.
Light Gray Fine Ballast	25 cu. in.	Wooden stirring sticks	4
Natural Fine Talus	10 cu. in.	Black Foam Pencil	1
Harvest Gold Field Grass	1 gram	Profile Patterns	2

Additional items needed but not included (most are common household items):

graduated measuring cup
 masking tape
 white glue or Scenic Glue (S190)
 newspaper
 mixing bowl
 rectangular cake pan or paint roller tray
 track cleaner or 600-grit wet/dry sandpaper
 pan or bowl for water
 liquid detergent
 scissors
 straightedge/ruler/yardstick
 120 and 220-grit sandpaper
 drinking straw/eye dropper
 paint brush 1 1/2"-2" wide
 4 small cups for mixing pigments and earth undercoat

Materials found at your favorite hobby store

Woodland Scenics Low Temp Foam Glue Gun and Glue Sticks (ST1445)
 Woodland Scenics Foam Knife or Hot Wire Foam Cutter

*Product of US Gypsum

**Patent US 5839657, 6164555, 5215793, 5019431; GER-P69925603.8-08, P69026621.9; UK-1102897, 0496798

Adhesives and Special Tools

Woodland Scenics offers two different kinds of adhesives for SubTerrain products. Each has its advantages for different jobs. We are providing general instructions for using both of these products. **Woodland Scenics strongly recommends using the Low Temp Foam Glue Gun to complete the kit.** If you decided to use the Foam Tack Glue read this section and refer back to it as you are gluing the components in place.

Low Temp Foam Glue Gun and Glue

The first adhesive is the Woodland Scenics Low Temp Foam Glue Gun and Glue. The Low Temp Foam Gun will not melt or damage the foam components. It bonds almost instantly and is inexpensive to use. We recommend this product for gluing down Risers, Profile Boards and Foam Sheets. It sets much quicker than Foam Tack Glue and you will not have to disassemble your work to use it.



However, it can leave lumps if used underneath thin materials like Risers, Incline Starters or Track-Bed. To use the Low Temp Foam Glue Gun and Glue merely run a continuous bead at the seam of the materials you are bonding (Fig. 5, pg.10). If you wish to use the Low Temp Foam Glue Gun and Glue, it is available at your favorite hobby store on the SubTerrain Merchandiser. *Important: Do not use a high temperature glue gun on this kit. It can damage the foam components.*

Foam Tack Glue

The next adhesive is our Foam Tack Glue. This product is a specially formulated glue that is safe and easy to use with foam. Used properly you can use it to assemble this entire kit. **A small portion of Foam Tack Glue has been supplied so you may use it to glue down the Track-Bed and track.** You will need to buy more if you choose to use it to glue down your other components. It is available at your favorite hobby store.



Foam Tack Glue is especially useful when gluing together thin or narrow pieces of foam. However your work must remain pinned down with Foam Nails until the Foam Tack Glue dries (about 12 hours). Foam Tack Glue must be spread evenly over the surfaces being glued together, so you will have to unpin Risers, Inclines and other components in order to apply the glue. When applied to both surfaces and allowed to dry for a short period of time, it acts like contact cement.

If using Foam Tack Glue to secure the foam, follow these steps:

- A. Pin foam components to be glued in place to ensure position.
Remove them individually to apply glue.
- B. Spread a thin layer of Foam Tack Glue on contact surface of foam and area where it will be placed.
- C. Wait for glue to become tacky (about 10 minutes).
- D. Replace component and pin it firmly in place. Repeat these steps for the entire layout.

Hot Wire Foam Cutter

The Woodland Scenics Hot Wire Foam Cutter was designed for use with Woodland Scenics patented foam components. It is the quickest, easiest way to cut foam. An accessory you can buy called the Bow & Guide Attachment makes the Hot Wire Foam Cutter even more versatile. Replacement nichrome wire is also available. If you want to use the Hot Wire Foam Cutter to build your layout, go to your local hobby store and purchase one. You will find it with the other SubTerrain accessories.



Track

We used Atlas Snap-Track to build this kit, but you can use Flex Track if you prefer. Both types of track have their advantages depending on your requirements and experience. For track requirements, refer to the list at the back of these instructions. *Note: When assembling track it is important to remember that once the Risers are in place, the track does not have to be centered with the track plan. Just make sure track does not protrude beyond edge of Risers and the train should function properly.*

Begin the layout

Here's a tip before you begin: To save some time, consider making the rock faces you will use to landscape the layout. Since the Lightweight Hydrocal takes some time to dry, you'll already have that part finished when it's time to place the rocks. To do this turn to page 25 and follow the steps to "Make and Place Rock Castings (pg. 26)."

Glue base panels

Place the base on a large flat surface with the track plan facing up. Glue the three panels together and pin them at the seams with Foam Nails if necessary (Fig. 1). Wipe off excess glue from the seams.

Sort the track pieces and assemble them according to the track plan printed on the base. When you are

satisfied that all the connectors fit properly without crimping, use small strips of masking tape to join the track segments. Then, remove the assembled track **IN THREE OR FOUR LARGE SECTIONS** so it will be easy to reassemble later. *Tip: store the sections of assembled track on top of a large sheet of cardboard to make it easier to move.*

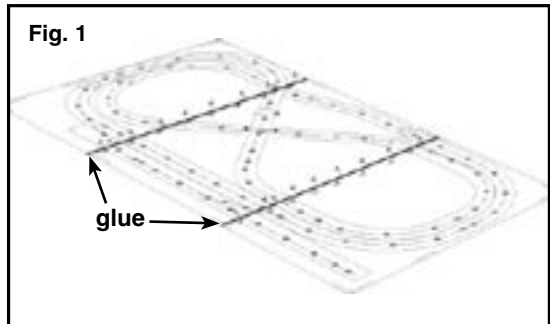

Install Risers

Risers elevate the track above the base and allow you to add ditches, creeks and low-lying areas to the

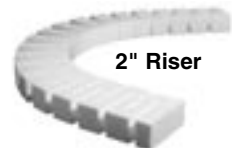

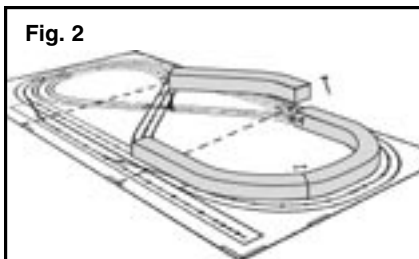

Fig. 2

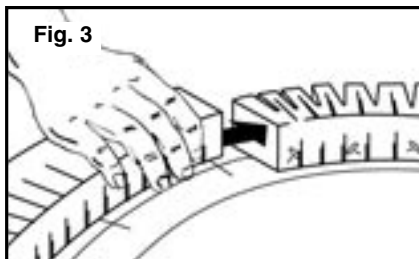

Fig. 3

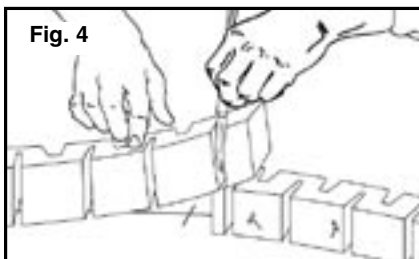

Fig. 4

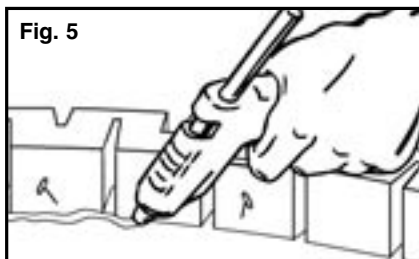

Fig. 5

layout without cutting into the base. The 2" Risers included in this kit will be enough to complete the track plan provided. Additional Risers have been provided for the NTRAK modular option (see back cover).

- A. Place the first tier of Risers by centering them over the preprinted track plan. They will cover the entire track plan without breaks. **You may begin anywhere on the track plan** (Fig. 2).
- B. Pin Risers to the base with Foam Nails every 4" to 6". Make sure the ends of each Riser butt together (Fig. 3). *Note: Cut the end of the last Riser with hobby knife so Riser ends fit snugly* (Fig. 4). **Always save foam scraps.**
- C. Once all the Risers have been pinned down, glue them to the base (Fig. 5). **We recommend using the Low Temp Foam Glue Gun for this step.** If you choose to use Foam Tack Glue, see section on Adhesives, page 8. Glue by running a bead of Low Temp Glue at the base of each Riser. Do this on both sides of the Risers for a secure bond.
- D. When adhesive has dried, remove Foam Nails.

Install Inclines

With the first tier Risers in place, it's time to install Inclines. Inclines add pre-calculated grades to the layout, letting your train climb and descend hills. This kit

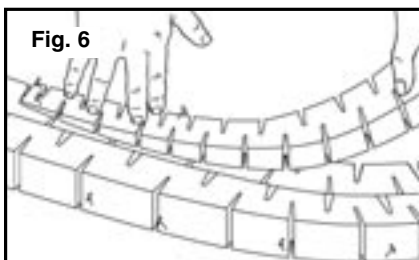
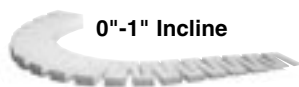

Fig. 6

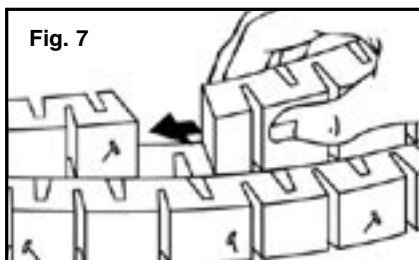
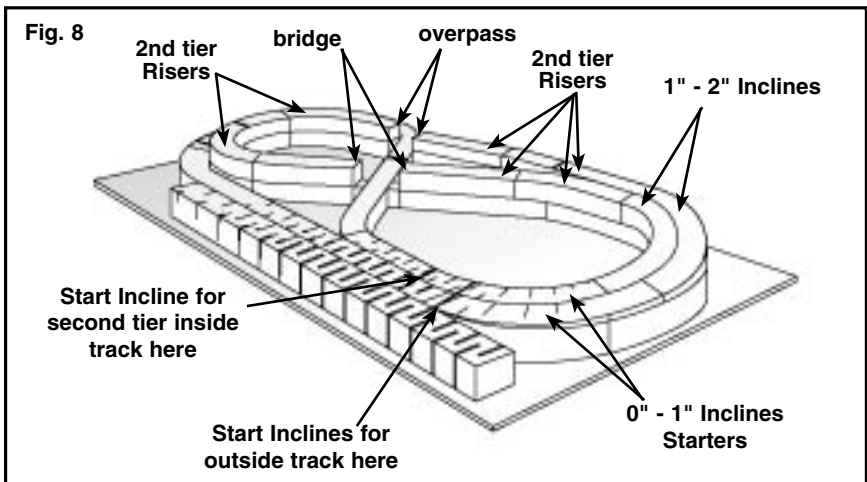

Fig. 7

includes two partial 4% Incline Sets. Each has two components - a "Starter Piece" that inclines from 0"-1" and a second piece that inclines from 1"-2".

- A. Begin with the "Starter Piece" (0"- 1"). On the track plan, find the text that says "Start Inclines For Second Tier Inside Track Here"(Fig. 8). Following the counter-clockwise direction of the arrow, place the "Starter Piece" on the Riser and pin it in place with Foam Nails (Fig. 6). We recommend using Foam Tack Glue to attach the thin end of the "Starter Piece" since it will not leave lumps. See "Foam Tack Glue" on page 8.
- B. Take the next section (1"-2") and butt it snugly against the first to create a continuous Incline. Make sure it is centered on the Riser and pin it in place (Fig. 7).
- C. On the track plan find the text that says "Start Inclines for Outside Track Here" (Fig. 8) and repeat the process with the remaining Incline Set for the outside track following the counter clockwise direction of the arrow.
- D. When adhesive has dried, remove all Foam Nails.



Finish Installing Risers

Now you're ready to add the second tier of Risers.

- A. On the track plan, find the ends of both the Bridge and the Overpass (Fig. 8). Leaving gaps to place the Bridge and the Overpass, begin pinning the second tier of Risers on top of the first tier Risers with Foam Nails (Fig. 8).

Note: Make sure the first tier Riser crossing beneath the Overpass is not covered by the Second Tier Riser.

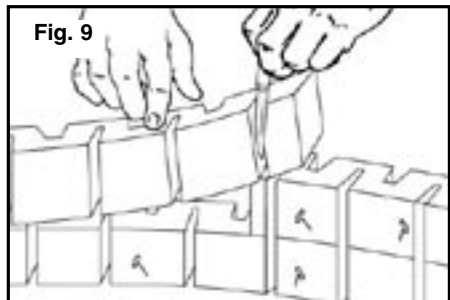

- B. Continue until second tier Risers meet the highest ends (2") of the Inclines.
- C. You will have to shorten the length of the last Risers so they will fit snugly against the highest ends of the Inclines. Do this by trimming them with a Woodland Scenics Hot Wire Foam Cutter or hobby knife (Fig. 9). Remember to save your scrap foam.
- D. When they are centered and butted against the high end of the Inclines, glue the second tier to the bottom Risers. Either gluing method will suffice, but we recommend running a bead of Low Temp Foam Glue between the edges of the top and bottom Risers.
- E. When adhesive has dried, remove all Foam Nails.

Overpass and Bridge

Install Overpass inside Tunnel

Follow these steps to place the Foam Overpass that sits inside your tunnel. Check the preprinted track plan (Fig. 11) and find the designation for the Overpass that will sit on the inside of the tunnel. It is located toward the back, left side of the layout.

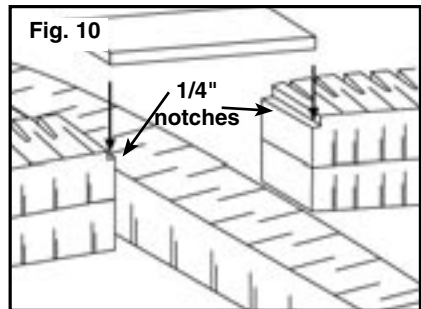

- A. Cut a 2-1/2" wide segment from the 1/4" Foam Sheet that is 1/2" longer than the gap left for the Overpass to fit the notches in the next step. Use a straightedge for a more precise cut.
- B. Cut notches exactly 1/4" deep and 1/4" in on both ends of the Risers where the Foam Overpass will sit (Fig. 10). You can use the 1/4" Foam Overpass to help measure the depth of the cut.
- C. Test place the Foam Overpass and adjust it-until it fits flush with the top of the Risers.
- D. If you have cut too deeply, use a small sliver of scrap foam to adjust the difference in height or simply hold the Foam Overpass in place while gluing.
- E. When satisfied, glue the 1/4" Foam Overpass into place.

Bridge

No special requirements are necessary for the Bridge (not provided) that will be outside the tunnel. It should be installed like a section of track. Check the preprinted track plan to make sure of placement. If you decided to use a section of foam or Masonite instead of a prefabricated bridge, follow the same steps as you did for Overpass on the inside of the tunnel.

Test track and sand Risers and Inclines if necessary

Now is a good time to test your track. Reassemble it and run the train. If you have areas on your Risers or Inclines that are uneven or too high, simply sand them down with fine-grit sandpaper. Remember to remove the track in three or four large sections for easy reassembly.

Overpass Adjustment for Taller Trains

Although most rolling stock will clear the bottom of the Overpass inside the tunnel area, a very small percentage of rolling stock (flatcars with a tall load) may exceed height clearance. Before constructing Scenic Ridge, check clearance for your train under the Overpass inside the tunnel area. To test for clearance, set your tallest rolling stock on a level surface and measure the height. If height exceeds $1\frac{3}{8}$ ", make the following adjustment to the Overpass inside the tunnel.

To adjust Overpass inside tunnel

- A. Purchase one package of 2% Starters (ST1412) from the SubTerrain System at your local hobby store.
- B. With a hobby knife, cut two Starter pieces at the $\frac{1}{4}$ " high mark (roughly the middle of the Starter). Set aside.
- C. From a $\frac{1}{4}$ " Foam Sheet cut a $2\frac{1}{2}$ " x 7" piece. Glue the piece in place overlapping the ends of the Risers on either side of the gap equally.
- D. Glue the cut Starter pieces on top of the Riser, butting the $\frac{1}{4}$ " ends against the ends of the installed Overpass (Fig. 11).

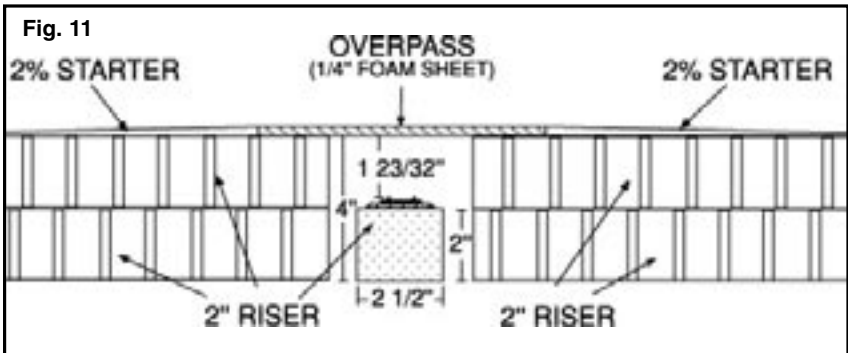

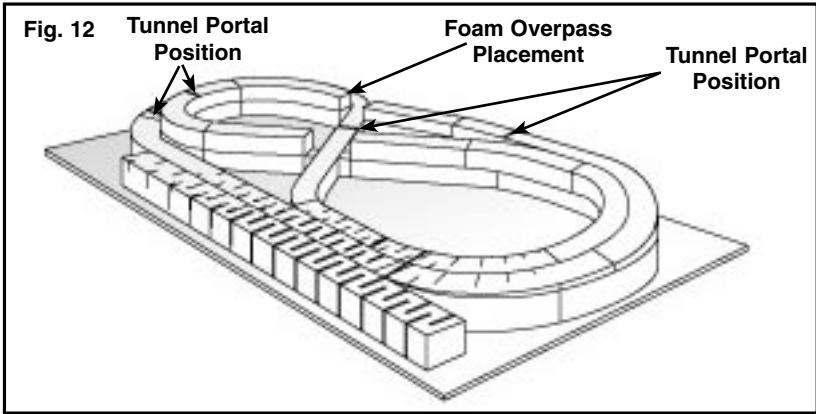

Tunnel Work

For convenience and ease of assembly, you should place the Plaster Cloth, Track-Bed, track and Ballast on the Risers that will be inside the tunnel before building the Tunnel Walls. Otherwise these areas will be difficult to reach. The area inside the tunnel begins at the Tunnel Portal markings on the track plan (Fig. 12).

Begin by placing Plaster Cloth for tunnel area Risers.

- A. Open the small package of Plaster Cloth and get a bowl or paint tray of water.
- B. Cut out several 4" x 4" squares of Plaster Cloth. They will overlap the edge of the Riser between 1/2" and 1".
- C. Hold the first strip of Plaster Cloth at the top corners and dip it into the bowl of water.
- D. Starting at approximately 6" outside the Tunnel Portals marked on the preprinted track plan and working inward, lay the strips of Plaster Cloth on the Riser bumpy side up (Fig. 13).
- E. Butt the ends of the strips together without overlapping them or leaving an uncovered seam.
- F. Smooth out all the lumps and folds as you go by rubbing the surface with your fingertips.
- G. When you reach the Foam Overpass inside the tunnel make sure the edges of the Plaster Cloth wrap around the bottom of the Overpass and do not hang loosely (Fig. 14).

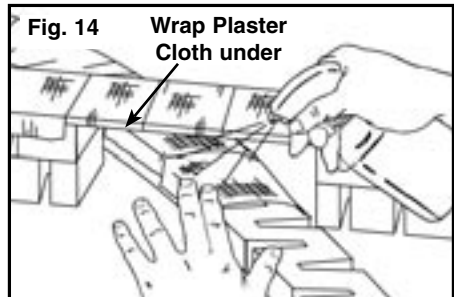
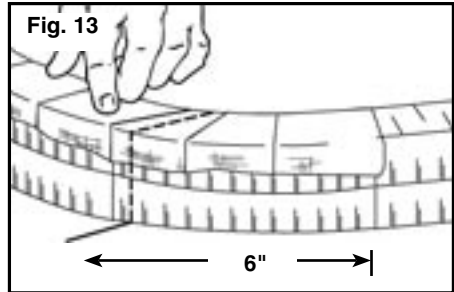

Lay Plaster Cloth at the Overpass and other tight spots.

For the area under the Foam Overpass, it is easier to lay a dry strip of Plaster Cloth on the lower Riser and mist it with water from a Scenic Sprayer, smoothing it down after it's already in place (Fig. 15). That way the Plaster Cloth won't twist or fold before you can place it. This method also works for other hard-to-reach areas. After you've covered all the areas that will be inside the tunnel, let the Plaster Cloth dry 4 to 6 hours and sand out any large bumps. Now it's time to lay the Track-Bed.

Lay Track-Bed inside the Tunnel area

- A. Assemble entire track.
- B. When you are satisfied with track position, temporarily pin it down with Foam Nails.
- C. Trace around the edges of the track on the Plaster Cloth inside the tunnel area with the Foam Pencil to form a guide for laying the Track-Bed.
- D. After tracing the track plan inside the tunnel area, remove the track from the layout in several large sections and store it on a sheet of cardboard.
- E. To lay Track-Bed spread an even layer of Foam Tack Glue on the bottom of the Track-Bed and another layer over the Plaster Cloth where you've traced around the track.

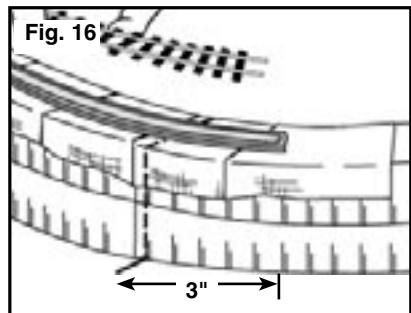
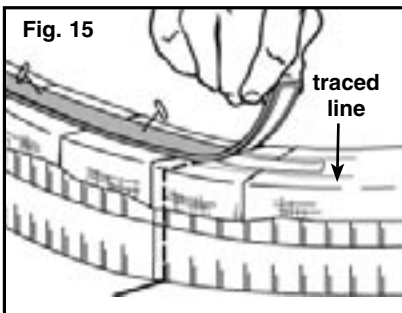

- F. Lay the Track-Bed on top of the traced track plan inside the tunnel area keeping it as centered as possible (Fig. 15).
- G. Place Foam Nails in the center of the Track-Bed (every 2" on curves, every 6" on straights) to hold it in place as it dries.
- H. Approximately 3" should protrude from the Tunnel Portal markings on base (Fig. 16). Trim excess.
- I. When Foam Tack Glue has dried, remove Foam Nails from Track-Bed. After the Track-Bed is secure and the Foam Nails are removed, it's time to glue down track and add the Ballast to the area inside the tunnel.

Place Track and Ballast inside Tunnel

Before beginning this step, make a solution of "wet water" by mixing one or two drops of liquid soap in six ounces of water. This will ensure that the Ballast doesn't clump when securing it with Scenic Cement.

- A. Replace the track over the entire layout to ensure a proper fit inside the Tunnel. Pin down sections inside Tunnel.

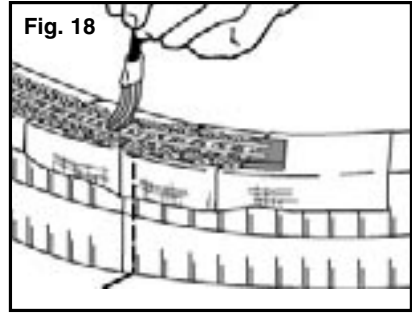
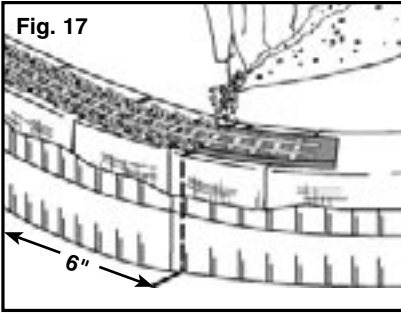

- B. When you are satisfied that any problems have been fixed, remove the track that is **outside the Tunnel area leaving the track inside the Tunnel area in place**. Roughly 3" of track should extend beyond Tunnel Portal markings on base.
- C. Glue down the track inside the Tunnel area one section at a time by removing it and spreading an even layer of Foam Tack Glue on top of the Track-Bed.
- D. Pin the track down to the glue-covered Track-Bed, making sure the connections between each track section are secure.
- E. Open the bag of Ballast and pour an even amount over the track 3"- 6" inside the Tunnel Portal (Fig. 17). This step is for continuity and appearance. You do not have to cover the entire length of track inside the Tunnel area.
- F. Brush off any Ballast that is on-the ties or rails (Fig. 18).
- G. Apply several drops of "wet water" over surface of Ballast.
- H. Spray Ballast with Scenic Cement to secure (Fig. 19).
- I. Important: Clean Scenic Cement from rails by wiping thoroughly with a dry rag.
- J. After Foam Tack Glue is dry, remove pins from track.

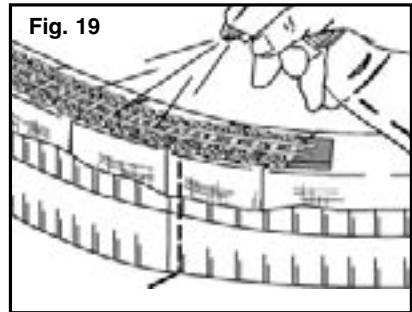

Place Foam Tunnel Portals

Now cut replicas of the Tunnel Portals from the 1/2" Foam Sheets (Fig. 20). These "Foam Portals" serve as a reference for Tunnel placement and will later provide a stable backing for the Hydrocal Tunnel Portals.

- A. Cut out the Tunnel Portal pattern from Pattern Sheets.
- B. Place Tunnel Portal Pattern on the end of a 1/2" thick Foam Sheet and trace around the edges to form four Foam Tunnel Portals (Fig 20).

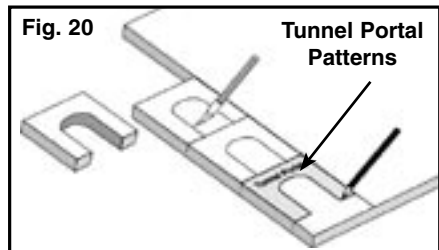

- C. Cut out the Foam Tunnel Portals with a hobby knife (Fig. 20).
- D. Locate the four Tunnel Portal positions on the track plan (Fig. 22) and pin the Foam Tunnel Portals in place with the Foam Nails (Fig. 21). Sides will protrude over edges of Riser.

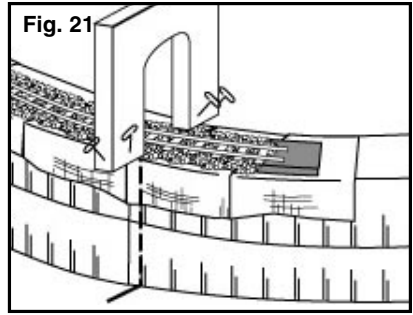

Tunnel Walls

- A. Cut two of the 1/4" Foam Sheets in half lengthwise to create four 6" by 24" pieces. These will become the tunnel walls that attach to the backs of the Tunnel Portals and sides of the Risers.
- B. Take two of the 6" by 24" segments and gently flex them back and forth so they will not break when following the contours of the Risers. These are walls A and B. Pin them to the backs of the Tunnel Portals and sides of the Risers (Fig. 22).
Note: The tops of the tunnel walls should be even with the tops of the foam tunnel portals. Trim walls to fit.
- C. Take another 6" by 24" segment and cut out two 3" by 6" segments. These are Walls C and D. Pin walls C and D to the backs of the Tunnel Portals and sides of the Risers (Fig. 22).
- D. Use the last 6" by 24" segment to form walls E and F. Cut this segment in half widthwise to form two 6" by 12" segments. These are walls E and F.
- E. Test-place 6" by 12" halves by placing them against the back of the center Tunnel Portal and the sides of its Riser. Trim halves to fit the area from the back of the center Tunnel Portal to walls A and B.
- F. Pin walls E and F against the back of the center Tunnel Portal and sides of its Risers.

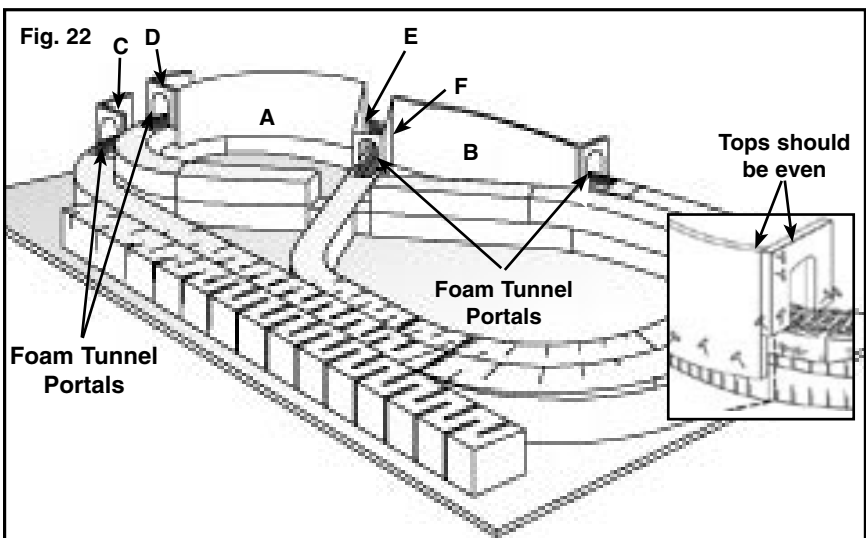

- G. Cut the tops of walls E and F to angle downward from the tops of walls A and B to the top of the center Tunnel Portal (Fig. 22).
- H. Glue walls and Portals in place when satisfied with their position.
Remove pins.

Note: Now is a good time to paint the inside of the Tunnel Walls. For longer walls (A, B, E, F) paint a 6" deep area inside the tunnel. Pour a small amount of black paint provided into a wide mouth container and use a 1-1/2" to 2" brush to apply.

Profile Boards

Profile Boards are the next step in the process. Profile Boards are interlocking foam components you place around the edge of the layout to form profiles for mountains and hills. You will have to cut the Profile Boards to get them to fit the perimeter of your layout. Profile Boards are packaged interlocking face-to-face. Pull them apart at the ends before beginning. Connectors interlock Profile Boards at the seams in a tongue-and-groove fashion.

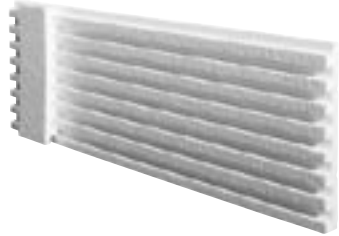

Note: For clarity, we have not included illustrations of Risers, Inclines and Tunnel Walls which are already in place.

Back Profile Boards

You will use 5 Profile Boards and 3 Connectors to build the back Profile Board Configuration.

- A. Begin at the rear, left corner and assemble the Profile Boards and Connectors to the back of the layout (Fig. 23). The ribbed side of the Profiles Boards always faces inward. *Note: Profile Boards have a wide edge and a narrow edge. For the back of the layout, the wide edges should set on the base. You will have to flip side Profile Boards narrow side down to interlock them at corners.*
- B. Test place the last Profile Board on the right side of the layout. It will extend beyond the back corner. With a straightedge, trim it to fit the base exactly by cutting off approximately 1" from the end of the Profile Board (Fig. 23).
- C. When Profile Boards are aligned with the back edge of the base, pin them into place with Foam Nails.

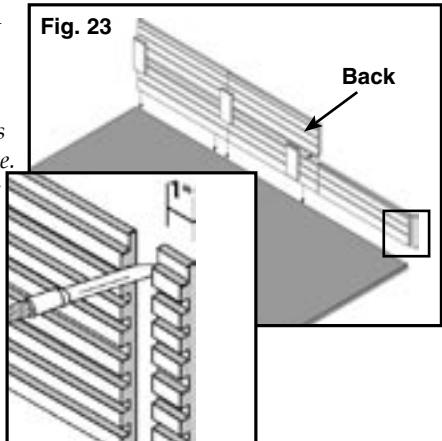

Left Profile Boards

You build the left side Profile Board configuration using 2 full Profile Boards, an 11" segment, and 2 Connectors.

- A. Measure and cut an 11" segment from the end of one Profile Board as shown in Fig. 24. This will leave a 13" length you will use later for the right side of the layout.
- B. Assemble the 2 full Profile Boards and 11" segment for left side (Fig. 24). *Remember: Profile Boards must be turned with the narrow-edge down for them to interlock at the corners.*
- C. Once the corners of the back and side Profile Boards are locked into place, align the edges of the side Profile Boards with the edges of the base.
- D. Pin them into place.

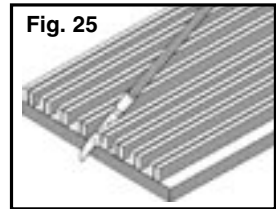
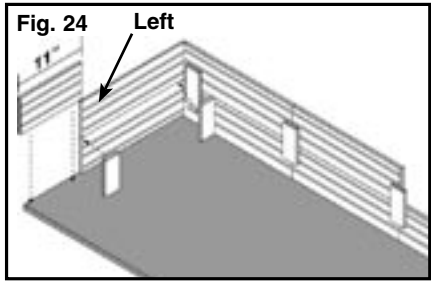

Front Profile Boards

You will use the 2 remaining Profile Boards to build the Front Profile Board Configuration.

- A. Cut the 2 Profile Boards in half lengthwise. To do this count in 4 ribs inward from the narrow edge and cut at the right side of this rib (Fig. 25).
- B. Cut one 8" Connectors in half widthwise. Use these 4" segments to connect the shortened Profile Boards. They may also be used to reinforce the corners.
- C. Using the three long pieces for the front of the layout assemble as shown in Fig. 26. Trim 1" from one of the ends for a proper fit.
- D. Place three of the half front Profile Boards and pin them into place.

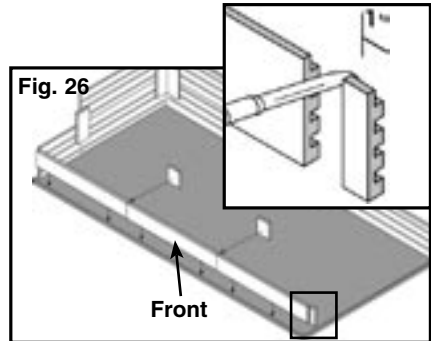

Right Side Profile Boards

- A. Trim 2" off one end of the remaining 13" segment. Cut 2" segment in half widthwise to form last 2 Connectors.
- B. Cut 11" segment in half lengthwise.
- C. Connect 11" segment and last full length half together (Fig. 27). Pin in place.

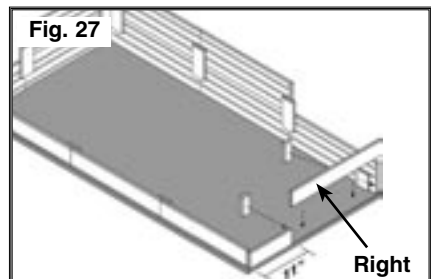

When all Profile Boards are in place and you are satisfied with their position, glue them to the base, at the seams and at the Connectors. Remove Foam Nails.

Trace and Cut Terrain Contours and Access Panels

Cut out the paper Contour Patterns provided. Following directions on pattern sheets, tape sections together and cut out rectangles for Access Panels from paper patterns. Pin patterns to the back, sides and front of the Profile Boards with the straightedges even with the bottom of the base (Fig. 28).

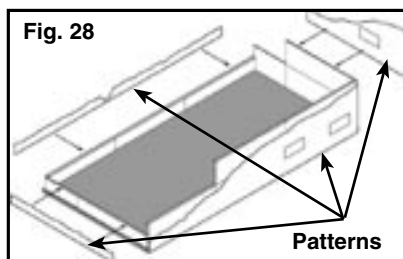

Use Foam Pencil to trace position of Access Panels on back and left side Profile Boards and the terrain contours. Remove patterns. Cut out the terrain contours (Fig. 29). If you are using the Hot Wire Foam Cutter this is a good time to attach the optional Bow & Guide Accessory. Using a knife and a straightedge cut out all three Access Panels. Keep the scrap sections of Profile Boards for later use.

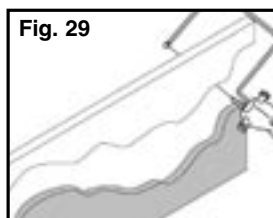

Cut sections of Connectors and attach them to the Profile Boards inside the layout. These will act as “latches” for the Access Panels (Fig. 30).

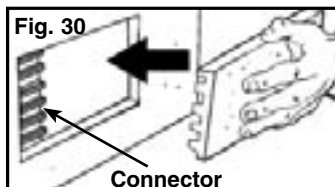

Fill Corner Joints Where Profile Boards Meet

To fill the joints where the Profile Boards interlock at corners, take several scraps of Profile Boards and cut out a few 4" to 12" strips from the rectangular flat areas between the ribs (Fig. 31). These rectangular strips will fit the right-angle gaps of the corners perfectly. Cut or stack them to fit height of each corner. Glue in place when satisfied.

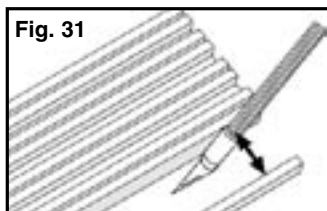

Build Tunnel Roof

Now that the Profile Boards are in place add the tunnel roof. The tunnel roof serves as a support for the paper wads that will be used in a future step.

- Take a full sheet of 1/4" foam and place it inside the layout against the ribs of the back Profile Board. It should slope slightly downward toward the front of the layout (Fig. 32).
- Cut notches into the Foam Sheet to accommodate the Connectors. Using the Foam Pencil mark Connector locations on Foam Sheet. Cut a 1" notch to allow the Foam Sheet to fit around the Connectors (Fig. 32).
- Pin the roof down and trim it to meet to outside edge of the tunnel (Fig. 32).

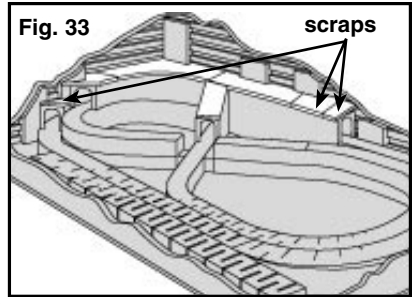
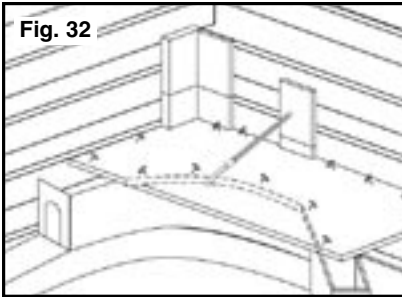

D. Take another 1/4" Foam Sheet and use it to make the remaining tunnel roof. Feel free to use scraps to fill the open spaces (Fig. 33). Neatness doesn't matter. The roof will soon be hidden under a layer of wadded newspaper and Plaster Cloth.

Foam Sheets (Level Areas)

Foam Sheets are also used to make level areas to place buildings, factories or entire towns. You will use the 1/2" Foam Sheets to form level areas inside the turns.

Measure and Cut Foam Sheets to create flat areas

- A. To install Foam Sheets take one of the remaining 1/2" Sheets and place it on top of the far right hand Riser (Fig. 34).
- B. Use the Foam Pencil to trace the shape where it meets the back and side Risers underneath the sheet. Although the Sheet should fit as close to the back and side Risers as possible, you should leave about a 2" gap toward front of the layout (Fig. 35).
- C. Trim the section to fit and get another 1/2" Foam Sheet. In the same manner cut it to fit the remaining area as shown in the illustration (Fig. 35). Gaps have been left around the back and right edge of the left side foam sheet to later add a drainage ditch or streambed (Fig. 35).

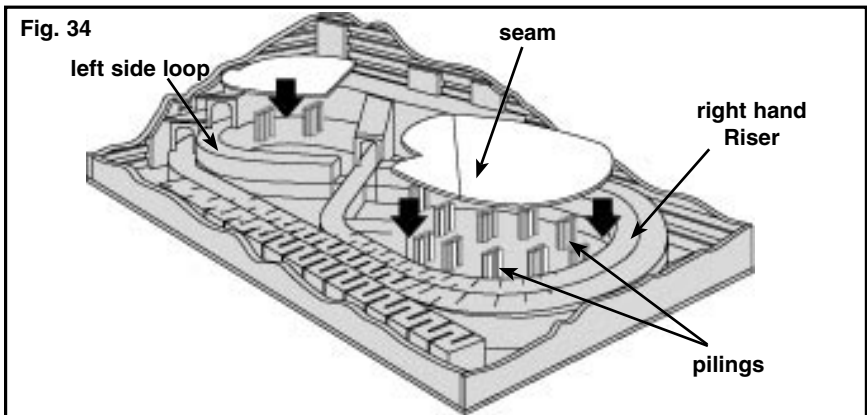
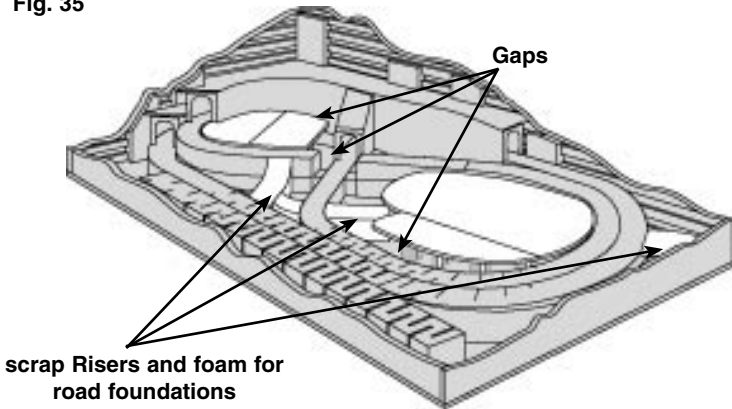

Fig. 35



Make Support Pilings for the Foam Sheets

The Foam Sheets will need support from underneath. Using scrap pieces of Profile Board or other foam cut a dozen equal-sized “pilings” to support the Foam Sheets. For the right hand side of the layout cut approximately one dozen “pilings” 2 3/4” tall to support the Foam Sheets (Fig. 35). Pay close attention to the seam between the sheets. Extra support may be needed there. Repeat the procedure for the area on the left side of layout except cut pilings 3 1/2” tall.

Glue down Foam Sheets

When satisfied with the placement of the pilings, glue them to the base and set the Foam Sheets in place. If Foam Sheets fit, glue them to the pilings and the edge of the Risers.

Test Place Buildings

If you are going to add buildings to the layout, now is a good time to make sure they fit in the areas you have in mind. For the layout on the box lid, we used DPM N-Scale Buildings numbers 501, 502, 503, 504, 506, 507, 508, 511, 512, 513, 514, 515 and 516. Test place the buildings in the areas you want them, making sure there is plenty of clearance for the train and landscaping products.

Add Risers to give the Road System a Foundation

This kit comes with the Woodland Scenics Road System. The Road System helps you make realistic roads and paved areas. At this stage use scrap sections of Risers or other foam to create foundations for the roads. Look at Fig. 35 for placement of scrap Risers. They will follow the same course as the Roads you make in a future step. For now just pin these scraps even with the tops of Foam Sheets and the Risers the train will use. When satisfied with the position of the scrap pieces, glue them into place and remove Foam Nails. They will be covered in Plaster Cloth in a future step.

Wiring

Before creating a Plaster Cloth shell, wiring should be installed. Installing wiring is easy with Scenic Ridge. Simply run wire along, and through Risers to connect the track to the power supply and switch control boxes.

Locate wiring positions on turnouts and track. Leave about 3" of wire unattached and temporarily tape over the exposed ends.

Make a hole in the foam just large enough for the wire, or run wire down the sides and along Risers and Inclines. Tape or glue wire to base.

If you prefer, drill a hole through the Inclines, Risers and the base. This hole should be just large enough for the wire to pass through (an awl or ice pick can even be used to make it). On the underside of the layout, route the wiring to the power supply or electric switches.

We recommend leaving a single exit point for the wiring to maintain a clean appearance. **When covering the layout with Plaster Cloth, be sure to consider the position of the wiring.**

Add Plaster Cloth and Track-Bed

With the Foam Sheets and wiring in place, it's time to lay the Plaster Cloth and Track-Bed. *Note: Before beginning this step make sure all the foam components are glued in place and Foam Nails are removed.*

Now its time to build the shapes of the mountains, hills and other terrain features. Do this by placing newspaper wads where these shapes will be. You may need several editions to create the terrain you want. Remember to leave a shallow "trench" down the front of the mountain to create a streambed (refer to Fig. 48). Do this by slightly parting the paper wads from the top of the highest mountain shape to the front edge of the layout. Consult the photograph on the box lid for suggested placement.

Make and place newspaper wads

- A. To wad a sheet of newspaper, begin at the outside of the sheet and roll the edges under to form a pillow, or mushroom cap shape. This shape is the easiest to stack for creating hills and mountains (Fig. 36).
- B. The wads should be stacked evenly with the top of the Profile Boards to form realistic contours. Fill in the spaces between Risers and around the perimeter of the Foam Sheets (Fig. 37).
- C. Use masking tape to hold the newspaper wads to each other and to the base.
- D. Make sure the train will have plenty of clearance around the Tunnel Portals. If you feel there are too many newspapers, remove some.

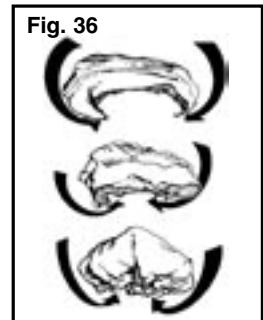

Place Plaster Cloth

Plaster Cloth adds a hard shell over the layout and creates a consistent surface to add landscape and scenery products.

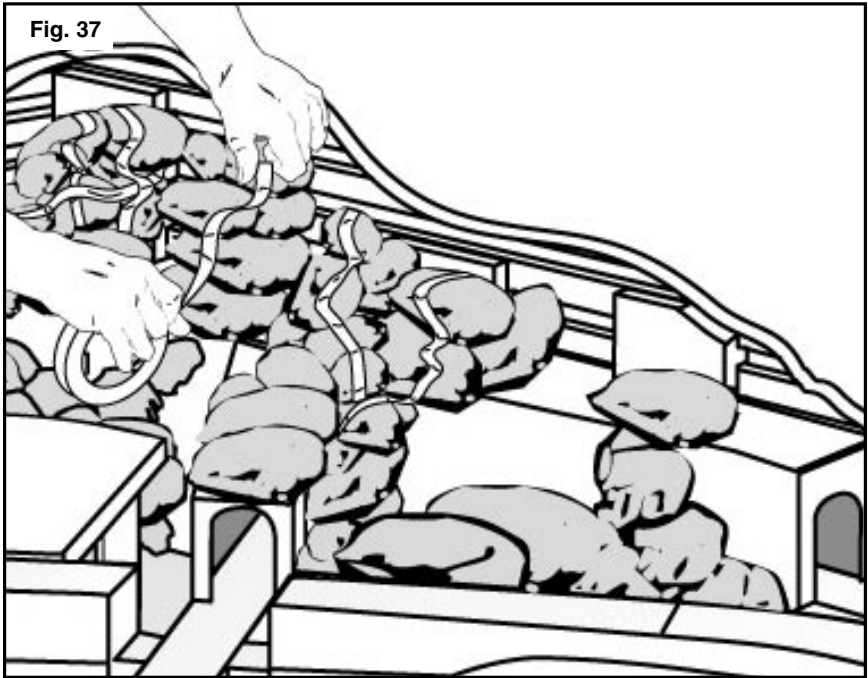

Fig. 37

- A. Cut one roll of Plaster Cloth into strips that are between 8" and 12" long.
- B. Take a strip and dip it into a pan (such as a cake pan or paint tray) of water holding the two top corners so the strip will not twist (Fig. 38).
- C. **Beginning at the bottom left hand corner of the layout** place the strip bumpy side up over the paper wads leaving a 1" strip overlapping the edge of the layout (Fig 39).
- D. Fold the overlapped end even with the edge of the layout to form a strong, finished edge (Fig. 40).
- E. Rub the Plaster Cloth with your fingertips to smooth out the bumps making sure most of the holes in the cloth are filled. Don't worry about wrinkles **except on the Risers** (see step "G" below). They add character to your terrain.

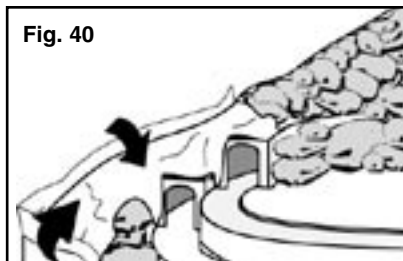

Fig. 38



Fig. 39

- F. Working from left to right, repeat the process for the remaining strips of Plaster Cloth **overlapping each strip 50% to form a double thick plaster surface**. Cover all the paper wads. Remember to leave a crease down the front of the mountain for the streambed.
- G. When covering Risers, butt ends of Plaster Cloth strips without overlapping them **making sure there are no bumps, wrinkles or folds in the Plaster Cloth**. They can cause problems later when you're laying the track. Let Plaster Cloth dry 4 to 6 hours.



Test Track. Redraw track plan on Plaster Cloth covered Riser

Once the Plaster Cloth has dried, it's time to test the track and redraw the track plan.

- A. Refit the track on top of the Plaster Cloth covered Risers.
- B. Hook up the power and test the train to make sure it doesn't derail and can clear Tunnel entrances.
- C. When a clear run is made, pin the track in place and retrace the pattern on the Plaster Cloth covered Riser **making sure a clear, distinct impression is made of the Track position. This will be your guide for laying the Track-Bed**.
- D. Remove the track in three or four large sections as before. Use pieces of masking tape to secure the individual track pieces if necessary.

Lay Track-Bed

At this stage you should glue the rest of the Track-Bed to the Risers.

- A. Following the track plan you just traced on the Plaster Cloth covered Risers, glue down Track-Bed over the remaining surface by spreading a layer of Foam Tack Glue on the bottom of the Track-Bed and another layer on the Riser (Fig. 41). Make sure Track-Bed is centered with the track plan. Pin in place.
- B. If necessary, place Foam Nails in the center of the Track-Bed (every 2" on curves, every 6" on straights) to hold it in place as it dries.
- C. Make sure the ends of each strip meet without bumps, ridges or

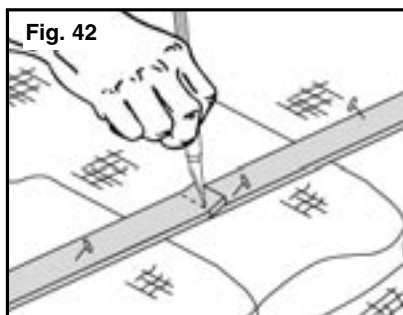
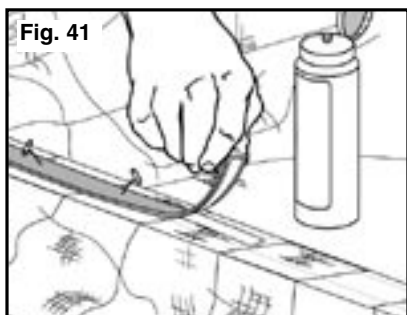

gaps. To do this, overlap both strips and cut through simultaneously with a hobby knife. The seams will match almost perfectly (Fig. 42).

- D. Cut Track-Bed to form areas for the turnouts (Fig. 43). Let dry and remove Foam Nails.

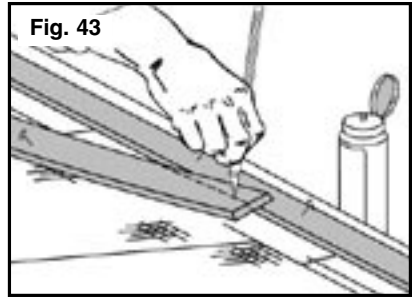

Fig. 43

Glue Down The Track

Work slowly and carefully at this stage, making sure all the track connectors are attached and the track is not crimped. This step is permanent. Accuracy is important for your train to run properly.

- A. Working from the Tunnel Portals where the track is already in place, glue the remaining track to the Track-Bed by spreading an even layer of Foam Tack Glue on top of the Track-Bed and attaching the track one section at a time (Fig. 44). Be sure not to use too much glue or get any on the rails.

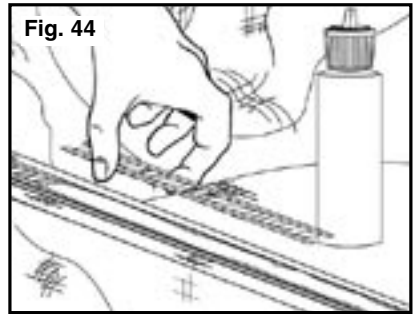

Fig. 44

This is especially important when gluing down the turnouts. **Make sure no glue gets near a turnout's switching mechanism.**

- B. Pin track in place and allow glue to dry.

Make and place Rock Castings

Now it's time to make the Lightweight Hydrocal rock castings. In this section you will prepare the mold, make rock castings, install them on the layout and color them.

Make Rock Castings

Remove the bag of Lightweight Hydrocal and gently turn it upside down several times to make sure it is mixed. Make another solution of "wet water" by mixing one or two drops of liquid detergent in six ounces of water. Coat the inside of the Rock Mold by swirling a small amount of the "wet water" inside both molds. This will help prevent air bubbles in the mold.

- A. Measure 7-1/2 oz. of water into a paper bowl.
- B. In a separate container measure 2-1/2 cups of Lightweight Hydrocal.
- C. Add the Lightweight Hydrocal to the water. Stir thoroughly and immediately pour into both molds. **This will fill both molds once.** Fill to the top of mold, but don't go over. Tap mold gently on the table to bring air bubbles to the surface.
- D. Clean tools and containers.
- E. Allow rocks to dry 1-2 hours before removing from mold.

Important: Leave 1 1/2 cups of unmixed Lightweight Hydrocal to create a bonding formula to attach rocks and Culverts to the layout.

Install Rock Castings

Place Rock Castings against the flat, vertical walls of mountains. You may have to cut the Plaster Cloth and push it inward to create flat surfaces. For suggestions, examine the picture on the box. Just remember that they will look more natural on a steep hillside with the strata layers running horizontally.

- A. Take one of the castings and trial fit it in place (Fig. 45). You will probably have to push in the Plaster Cloth for a flush fit (you can even cut into the Plaster Cloth with a knife if needed).
- B. Break rock castings into as many pieces as you wish. Broken rocks look perfectly natural and may provide some variety.

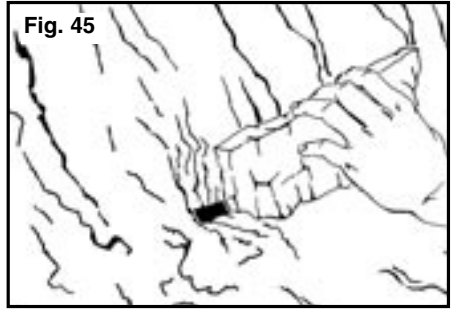

- C. Once you have decided where to place the rocks, it's time to permanently attach them to the layout. Install all rocks at this time for efficient use of the Lightweight Hydrocal adhesive mixture.



- D. **At this point, separate 2 level tablespoons of the remaining Lightweight Hydrocal and place them in a separate container to use later for bonding the Culverts to the layout.**
- E. Now create the rock adhesive, by mixing the remaining 1 1/2 cups of Lightweight Hydrocal with 4 oz. of water and mix well with a wooden stirring stick.
- F. Briefly soak the rock castings in water. Wet the Plaster Cloth where the rock is to be attached with a sponge or spray bottle. **Both the rock and the Plaster Cloth must be wet.**
- G. Spread a layer of Lightweight Hydrocal on the back of the rock casting and press it into place (Fig. 46). Keep the mixture off the rock face.
- H. Use Lightweight Hydrocal to fill in gaps around rock faces if necessary.
- I. Rinse off the stirring stick and mixing bowl.
- J. Allow to dry at least 12 hours or overnight before coloring.

Color Rock Castings

- A. Before coloring rocks, see photos on box for examples. Use three small cups or glass containers. Open pigment containers carefully.
- B. Mix pigments and water in 3 separate cups as follows: Black 1/8 tsp. to 4 oz. (1/2 cup) of water. Burnt Umber and Yellow Ocher 1/4 tsp. to 4 oz. (1/2 cup) of water. Stir thoroughly.

- C. These washes will be used to create random “leopard spot” patterns. Save left over wash for finishing touches. Stir the washes as you use them because they settle quickly.
- D. Dip the foam applicator in the Yellow Ocher wash. Daub random spots of yellow wash on about 1/3 of each rock face. Wash will be thin and runny.
- E. Rinse the pad and dip it in the Burnt Umber (brown) container. Repeat the leopard spotting process, again covering 1/3 of each rock face.
- F. Rinse the color out of the pad and dip it in the Black wash. Repeat the leopard spotting process.
- G. Finally soak the pad in the Black wash and daub over entire rock faces, letting the wash run into the cracks and crevices of each casting. This ties all the colors together. *Save remaining Black wash to color Hydrocal Tunnel Portals and Culverts.*
- H. Allow the Rocks to dry overnight. Store washes for touch up work.
- I. Examine the rock castings once they are dry and add color as you see fit.
- J. When you are satisfied with the color, apply a layer of Scenic Cement to set the wash. Take the bottle of Scenic Cement and shake it. Attach the spray head and set it to a fine mist. Spray the rock faces.

Install Hydrocal Portals & Culverts

Paint and place Tunnel Portals

Now it's time to Install the Hydrocal Tunnel Portals to the Foam Tunnel Portals you added earlier. You may have to cut into Plaster Cloth to get a proper fit at the Tunnel mouth.

- A. Paint Portals with remaining quantities of Black wash and Burnt Umber. Allow paint to dry.
- B. Take one of the Hydrocal Tunnel Portals and test place it at any one of the Tunnel openings. Make sure you center the Portal opening over the track.
- C. If the Hydrocal Tunnel Portal does not fit properly against the foam Tunnel Portal you installed earlier, take a knife or cutting tool (Fig. 47) and carefully cut the Plaster Cloth so it will fit. Press in small bulges in the Plaster Cloth with your thumb.
- D. Make sure your train has enough clearance to pass through the Hydrocal Tunnel Portal.
- E. Spread Foam Tack Glue on the back of the Hydrocal Tunnel Portal and the Foam Tunnel Portal.
- F. Wait a few moments for the Glue to become tacky and fit the back of the Hydrocal Tunnel Portal to the face of the foam Tunnel Portal snugly.
- G. Repeat procedure for remaining Tunnel Portals (Fig. 48).

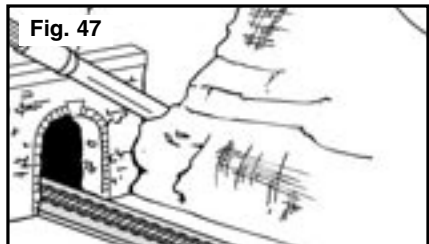

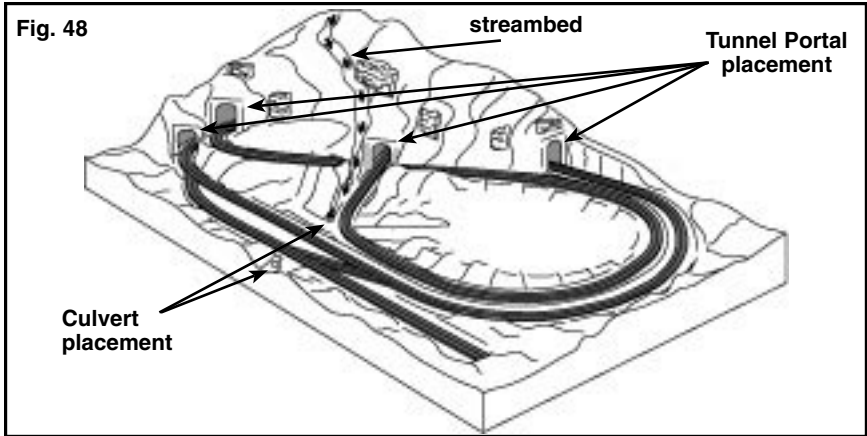

Paint and assemble Culverts

- A. Sand and prepare Culvert pieces.
- B. Paint all Culvert pieces with Black wash and let dry.
- C. Glue Culverts together at seams with Foam Tack Glue (Fig. 49).
- D. Cut Plaster Cloth to create recessed areas to accommodate assembled Culverts. They should be placed in the course of the streambed. Remove some paperwads if necessary.
- E. Place Culverts in recessed areas (Fig. 48).
- F. Mix the 2 tablespoons Lightweight Hydrocal saved from the previous step with 1-1/2 teaspoons of water.
- G. Use mix to attach Culverts to layout and seal gaps around Plaster Cloth.

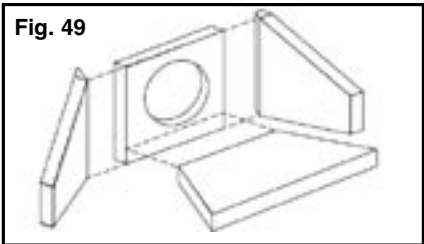

Plaster Cloth Sides and Front of Layout

This step is optional, but will add durability and continuity to the layout. In this step, take several strips of Plaster Cloth and pin them, dry, to the sides of the layout with the bumpy side facing out.

Front

For the front of the layout, it is recommended that you use a continuous strip (slightly longer than 6') that will allow a few inches to overlap the sides (Fig. 50). Pin the dry strip into place and spray it thoroughly with water, working the plaster with your fingertips as you go to fill in as many holes as possible.

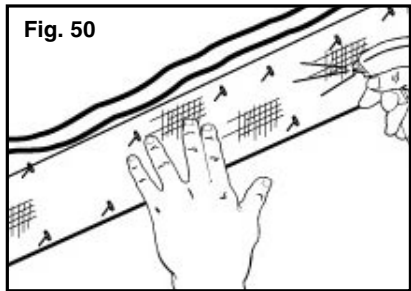

Sides and Back

Pin squares of Plaster Cloth to outside of Profile Boards. Pin 8" x 8" squares of dry Plaster Cloth in place and spray them with the spray bottle, rubbing the plaster as you go (Fig. 51). Overlap Access Panel opening by 1/2". When Plaster Cloth has dried overnight, cut out Access Panel opening with a knife.

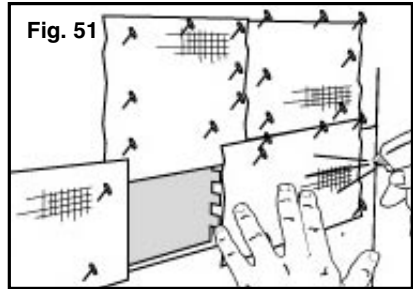

Add Road System

The Woodland Scenics Road Systems consists of Paving Tape, a plastic Spreader, Smooth-It (paving material) and Top Coat (in Asphalt or Concrete colors). It is the ideal system for adding realistic roads, streets, sidewalks or pavement to the layout.

Planning Roads and Paved Areas

Before beginning your Road System you must first plan the placement of the roads, town areas and crossovers. Although paved areas can be positioned wherever you wish, these instructions will show how to build the paved areas pictured on the box.

Begin by drawing an outline of your roads and paved areas with the Foam Pencil. Do this over the level areas where you want buildings and on the scrap Risers you installed earlier to provide foundations for the Road System. In N scale, country roads should be 1-3/8" wide and city streets should be 2-1/4" wide. For a diagram of road and pavement placement (Fig. 62).



If you wish to add buildings, now is a good time to test place them. Make sure building placement allows room for streets. Once you are satisfied with the placement of your roads and paved areas, it's time to begin.

Pave Areas for Town and Factory

Use the Road System to make large paved areas for towns and factories. In Figure 62 and the photo on the box we have created our town on the right hand side of the layout. Before permanently placing buildings and creating city streets, we first paved the large area on the right hand side of the layout. Doing this requires a special technique that will make the job easier. Later you can add another layer of pavement on top of this one to add foundations, curbs and sidewalks. **Always make sure the surface is very clean and dry.**

- A. Lay several parallel strips of Paving Tape about 2" apart across the area to be paved (Fig. 52).
- B. Mix Smooth-It according to carton directions. Apply Smooth-It to every other stripped section. Smooth evenly with Spreader (Fig. 52).

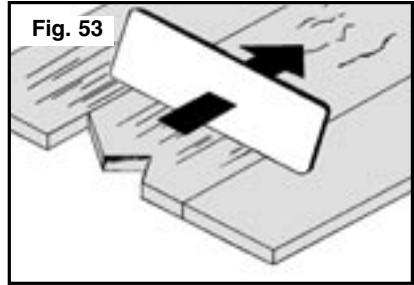
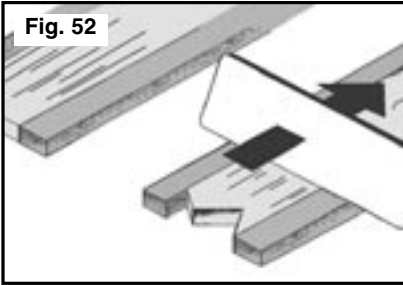

- C. Allow Smooth-It to dry thoroughly (about 20-30 minutes).
- D. Remove Paving Tape.
- E. Fill in remaining areas and smooth them evenly with tops of existing pavement with Spreader (Fig. 53).
- F. Allow Smooth-It to dry. Sand surface.

Build Roads

- A. Make sure the surface is clean and dry where you earlier drew the outline of the roads.
- B. Starting at the large paved town area, lay Paving Tape along outline of drawn road to form borders (Fig. 54).
- C. Mix a batch of Smooth-It according to directions on back of carton.
- D. Apply mix between strips of tape and use the Spreader to evenly spread Smooth-It. Be sure that Smooth-It covers the entire area between the taped edges. It should be even with the top of the tape when smoothed with Spreader (Fig. 55).
- E. When Smooth-It is dry, sand and paint with Top Coat of your choice.

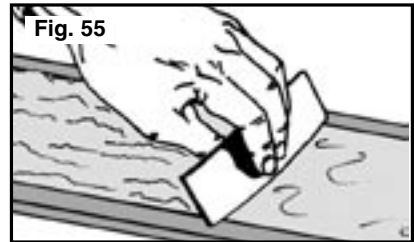
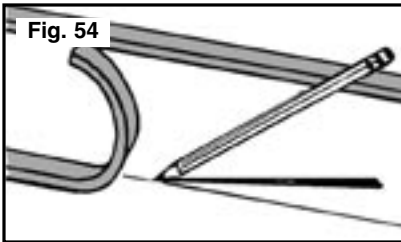

Create Road Crossings

To create a realistic appearance, you can add paved road crossings to the layout where the road will overlap the track.

- A. Track-Bed will need to be removed from both sides of the track where the road crosses the track (Fig. 56). Use a hobby knife to cut out and remove this material.
- B. Following the path of the roads place strips of Paving Tape up to the track where you removed Track-Bed. This is where the road will cross track (Fig. 56).

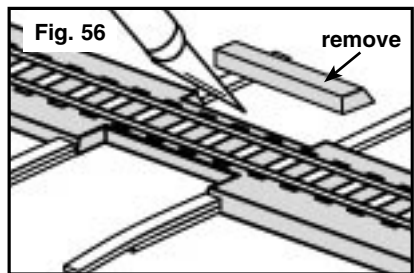

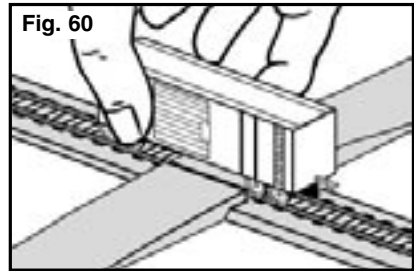
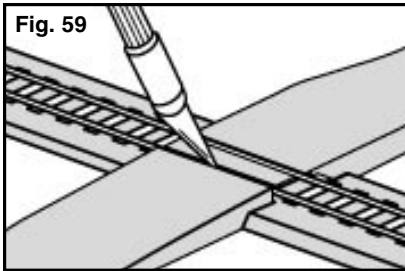
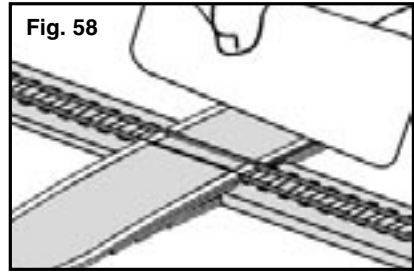
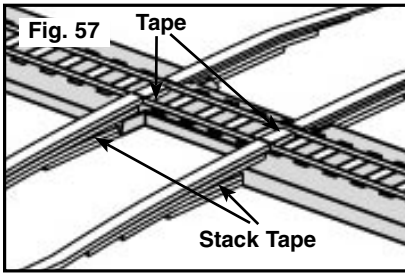

- C. Stack progressively longer strips of Paving Tape on top of the first to bring road crossing up to the top of the rail. **The last and longest piece of tape should butt against the side of the rail** (Fig. 57).
- D. Cut and place two small lengths of paving tape between the rails in line with the outside Paving Tape (Fig. 57).
- E. Fill all areas between the Paving Tape with Smooth-It making sure Smooth-It is even with the top of the rails (Fig. 58). **The finished road at the crossing should be the same height as the top of the rails on the track and the tops of the Paving Tape.**
- F. Use provided Spreader to level Smooth-It even with the tops of the rails and Paving Tape (Fig. 58).
- G. With your fingernail, remove excess Smooth-It from top of the rails.
- H. Let Smooth-It dry.
- I. Remove Paving Tape.
- J. Carefully run a knife down the inside of the rails several times, scoring a groove in the Smooth-It to allow clearance for train wheels (Fig. 59).
- K. Test clearance by running a rolling stock car over the area (Fig. 60). If necessary sand down Smooth-It in between rails.
- L. Repeat steps "J" and "K" until train has proper clearance.
- M. Paint with Asphalt or Concrete Top Coat and let dry.
- N. Use rolling stock to check for clearance again.
- O. Sand area and repaint if necessary.

Add Sidewalks, Curbs and Foundations (optional)

To make sidewalks, curbs and foundations in the paved areas of the town follow these steps.

- A. Allow Smooth-It in town area to dry. Remove Paving Tape.

- B. Following the desired path of your sidewalk, curb or foundation, lay strips of Paving Tape **over the existing dried Smooth-It on the inside edges** of all your roads inside the Town area (Fig. 61). *Make sure your new curbs line up with roads leading into town area.*
- C. Following the steps under "Pave Areas for Towns and Factory" apply another layer of Smooth-It over the area outside the road. This will elevate the area above the existing layer of Smooth-It creating a curb, sidewalk or foundation for your buildings (Fig. 61).
- D. When Smooth-It is thoroughly dry, lightly sand with 220-grit sandpaper.
- E. Paint raised foundation surface with Asphalt or Concrete Top Coat. We suggest using the Concrete Top Coat for the foundation or sidewalk area and Asphalt for the street. Paint all remaining paved areas.

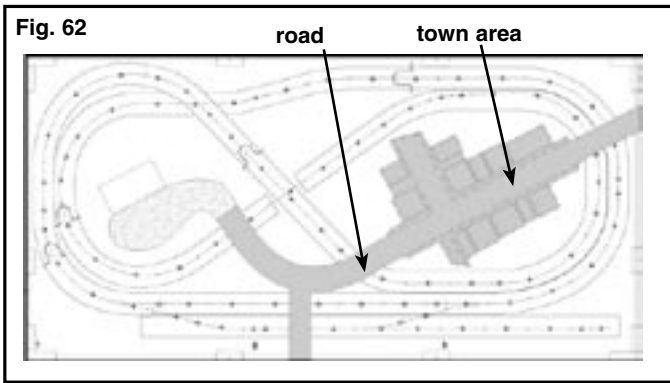
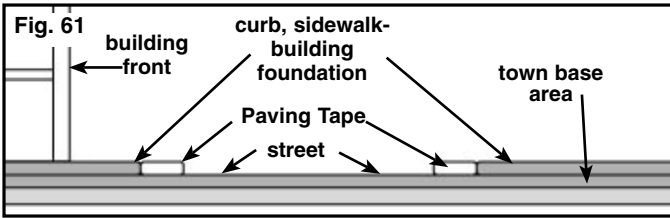

Ballast

Now it's time to ballast the track. Ballast is gravel or broken stones laid in a railroad bed to give strength and stability to ties and rails. The Ballast provided with this kit is in scale. It will cover the Track-Bed and add an extra degree of realism to the layout.

- A. Use the open bag of Ballast.
- B. Beginning at the far left Tunnel Portal, carefully but generously, pour the ballast directly over the track. Make sure no Track-Bed shows through on either side (Fig. 63).
- C. Continue until entire track is covered, being careful to avoid switches.

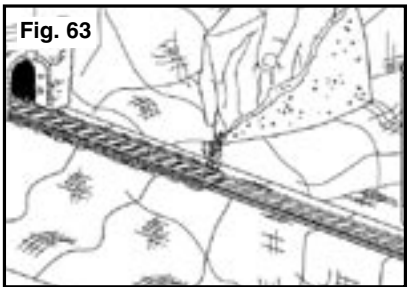

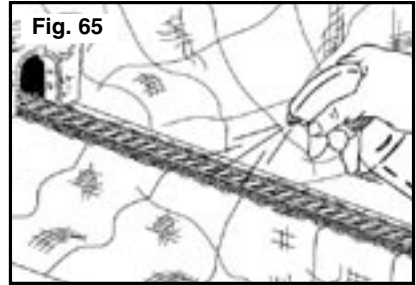
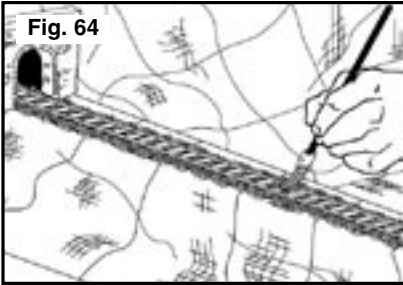

- D. Brush off all the excess Ballast from the ties and rail and spread evenly with a small paintbrush (Fig. 64).
- E. Make sure the Ballast on the sides of the track is slightly below the rail for a realistic appearance.
- F. With a spray bottle or eyedropper, spray Ballast with “wet water” to prevent clumping.
- G. Spray Scenic Cement thoroughly holding the bottle 12" to 18" above the layout. (Fig. 65)
- H. Clean rails after spraying Scenic Cement. Use sanding block with 600-grit sandpaper to keep rail surface even.

Scenery

After you've finished the roadwork and Ballast, the next step is landscaping. This step will add color, texture, and realism to the layout.

We will be using a transparent wash and irregular application for various turfs and other products in this section. There is no specific order in which many of the landscape materials must be added to a model or layout. In this kit we present one order of working, but feel free to alter it a little, if you wish, or return to an earlier section to add more of a particular product. You may need more or less of a specific product, depending on how you landscape your layout. If you run out of a material, or want more of a certain item, go to your local hobby store and find the Woodland Scenics Landscaping products.

Read through the instructions before beginning. **For suggested placement of Scenery materials consult the Legend on page 38.** *Note: You will be using Scenic Cement throughout this section. Always shake the bottle to mix it before spraying.*

Low Ground Cover

The first step in creating a realistic landscape is adding the low ground cover. This includes painting the white Plaster Cloth an earth color and adding the smallest plants and grasses. It also includes dirt and soil. Initially you will use these products rather sparingly. Later, you may want to add more to cover up seams, visible Plaster Cloth and similar areas.

Color Plaster Cloth. Sprinkle Turf.

- A. Cover the track and turnouts with masking tape.
- B. In a bowl, mix 2 oz. Earth Undercoat Pigment with 16 oz. water to make a wash.

- C. Use a 1 1/2" to 2" brush to apply the wash to all areas of exposed Plaster Cloth (**do not use wash or ground cover on rock faces, Tunnel Portals, track or pavement**). The wash is somewhat transparent and should appear very irregular, with light and dark areas.
- D. Allow Earth Undercoat to dry.

Sprinkle Blended Turf

- A. Next, cut off one corner of the bag of Green Blend Blended Turf and fill (do not pack) the supplied shaker cup to the 4 oz. mark. **Tape shaker lid on cup.**
- B. Spray a few square feet of the exposed Plaster Cloth with a mist of Scenic Cement.
- C. While Scenic Cement is still wet take the cup of Green Blend and lightly sprinkle a thin layer over the area sprayed with Scenic Cement, allow small portions of Earth Undercoat to be visible.
- D. Refill 4 oz. cup as necessary.
- E. When entire layout is lightly covered spray a second, thicker coat of Scenic Cement over the Green Blend.

Accent Turf

- A. Cut off one corner from each of the Fine Turf colors - Yellow Grass, Burnt Grass, Soil and Earth.
- B. Pour 1/2 bag of Yellow Grass into 4-oz. cup and lightly sprinkle on Plaster Cloth. Yellow Grass can indicate areas, which may not get as much water, such as the sides of slopes. Repeat with Burnt Grass, which provides a variation in the basic green coloring. Follow with Soil and Earth. These work well with gullies, drainage ditches, streambeds, trails, or similar eroded surfaces. Remember to blend the coverings. Don't worry about making a mistake. If you add too much of one color, just lightly sprinkle another color over it.
- C. When you are satisfied with the overall appearance, gently mist all Turf with Scenic Cement, beginning 18" to 24" away and gradually bringing the spray head closer to secure the Turf without blowing it away. Spray turf until thoroughly wet. Allow to dry.

Add Medium Ground Cover

Medium ground cover includes the vines, medium level weeds and miscellaneous plants. We have also included Talus (the rock debris found around rock outcroppings) in this section. Medium ground cover adds texture and realism to a model. When adding medium ground cover, most landscaping products will overlap. This adds a realistic touch to your layout.

Coarse Turf

- A. The Medium Green Coarse Turf provides texture variations and can indicate weeds, coarse grass, and small plants. With Scenic Cement, lightly spray areas where you will place turf. Sprinkle on Coarse Turf and pat to adhere. Note that the types of plants replicated by Coarse Turf would not have an even coverage over all the areas.

- B. With Scenic Cement, lightly spray areas where the different types of ground cover have been added.
- C. While Scenic Cement is still damp, carefully add a few small pinches of Coarse Turf to add color variation.
- D. Allow areas to dry completely.

Add Talus (Rock Debris)

Talus is the rock debris, which collects beneath cliffs, around the base of mountains, in erosion ruts and in front of the rock faces.

- A. Turn bag of Talus upside down to mix rock sizes. Cut off one corner of the bag and use it as a shaker to sprinkle the Talus. Be sure to add Talus below and around the rock

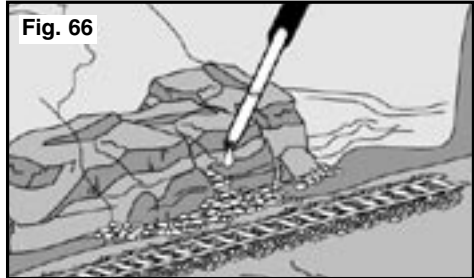

- outcroppings and cliffs, in erosion areas, creek beds, around Tunnel Portals, drainage ditches, wherever you feel it is appropriate.
- B. Mix equal parts of white glue and water and a drop or two of liquid detergent to make glue flow. With a straw or eyedropper, generously drop this mixture on the Talus to attach it. Allow to dry completely. When the glue is dry, apply another coat in the same manner and allow to dry (Fig. 66). Stain Talus with pigments left over from coloring your rocks.

Add High Ground Cover

High ground cover includes brush, shrubs, tall grasses and trees. When you have completed this section, you will be ready to add some finishing touches to your layout.

Assemble and Install trees

- A. Twist tree armatures to realistic, three-dimensional shapes (Fig. 67). Don't worry about breaking the armatures. They are made of a special pliable plastic.
- B. Brush Hob-e-Tac Adhesive on ends of branches, let dry approximately 15 minutes until clear and tacky (Fig. 68).

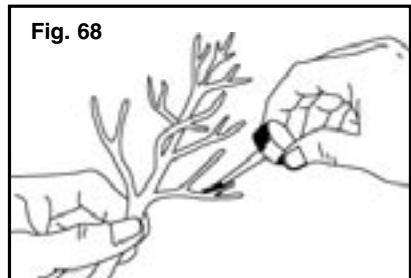

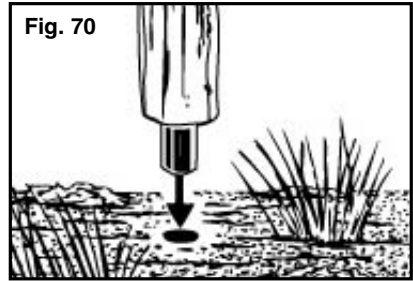
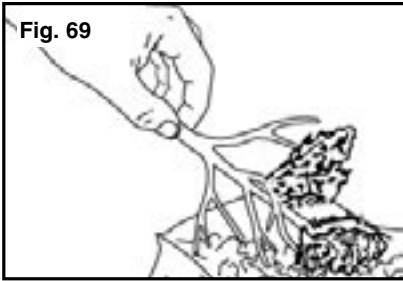

- C. Dip tree into the three different colors of Clump-Foliage for quick application. For a more precisely constructed tree, attach different colors of Clump-Foliage by hand. The results are similar. Use the method you prefer (Fig. 69).
- D. Shake excess foliage from tree and place it in the temporary stand.
- E. Repeat steps A-D for the remaining trees.
- F. With the point of a knife, make a small hole in the Plaster Cloth where you want to place the trees. If you change your mind on the location, just cover the small hole with ground cover.
- G. Remove tree from base. Place a drop of Hob-e-Tac on the bottom of the tree and plant the tree in the hole (Fig. 70).
- H. Repeat for remainder of trees. Placing trees in groups of three around the layout will provide a realistic appearance.

Clump-Foliage

- A. Create bushes and shrubs with Clump-Foliage. Place unglued Clump-Foliage around areas to see if they look appropriate. When you're satisfied with placement, place white glue on the layout where you want them and press Clump-Foliage in place (Fig. 71 and 72).
- B. Use all three colors of Clump-Foliage. Bushes generally grow in "family groups" of one color rather than a mix.
- C. Lightly spray the tops of a few of the Clump-Foliage bushes with Scenic Cement and sprinkle on Turf for highlighting.

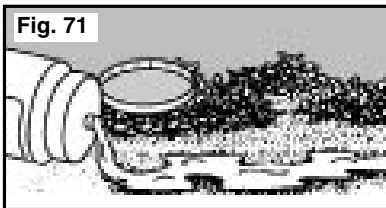

Field Grass

- A. Remove the Field Grass from the package. Separate a small clump from the batch and roll it between your fingers to produce uneven lengths (Fig. 73). With a pair of scissors, cut one end of the clump evenly to serve as the "bottom" of the grass (Fig. 74). Field Grass patches should be 1/4" to 3/8" to match scale.

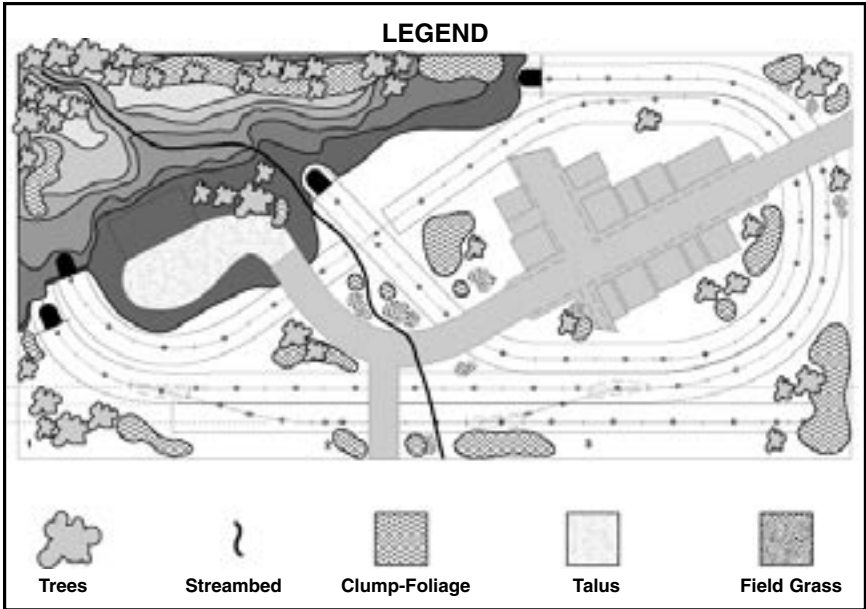

- B. On a scrap of paper place a small amount of Hob-e-Tac. Dip the bottom of the grass into the Hob-e-Tac and place it where desired on the layout (Fig. 75 & 76). Hold the clump until it can stand up on its own.
- C. Repeat process for additional clumps.

Paint the Profile Boards

Painting the Profile Boards and edges of the base will make the layout look even better by bringing out the vivid colors of the landscaping. Use the 8 oz. of Black paint provided, or purchase the color of your choice at your favorite hobby store. If you haven't already done so, this is also a good time to paint the inside of the Tunnel Walls black for cosmetic purposes.

- A. Pour bottle of the Black Base Paint into a wide-mouth container.
- B. Use a 1 1/2" to 2" brush (not provided) to paint the Profile Boards.
- C. Start with the front of the layout and work your way around (Fig. 77).

- D. Be careful to avoid edges where landscaping begins.
- E. Remove Access Panels to paint. **Do not paint inside edges of Access Panel or panel opening.**
- F. Clean brushes and allow paint to dry.
- G. Touch up areas where white base stills shows through.

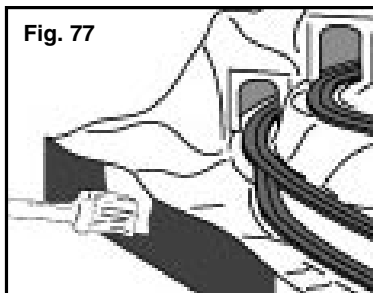

Detail Your Layout

A layout is never truly done because you can always add more scenery or details. Here are a few final touches you can make to add that extra layer of detail to your Scenic Ridge Lightweight Layout Kit. Before attempting any of these techniques, make sure all surfaces are dry from previous steps. We advise you read through these instructions before beginning.

Add additional landscape materials

- A. There may be several areas of your layout where you want additional landscaping to create color variation, add more color, cover up splotches of glue or plaster, or disguise some other undesirable features. Additional landscaping materials add texture and realism, and create more interest in the scenery.
- B. More Fine Turf, Coarse Turf, Clump-Foliage bushes and Field Grass clumps can easily be added at this time. Refer back to the original directions when adding more of these items.

Dry Brushing

- A. Dip a dry paintbrush with soft fibers into any of the colors of Fine Turf and brush it on the layout where you want it. Add some Soil or Earth Turf on top of the Talus and along the edges of the Ballast and rock castings to represent dirt which would collect there. Soil or Earth Turf may also be dry brushed on your layout to indicate dirt roads and paths.
- B. Dry brush some Burnt Grass or Earth Turf around the bottom of the trees to cover any Hob-e-Tac Adhesive and to model the weeds and grasses which might grow there. Use some Burnt Grass Turf around the base of the Field Grass to cover Hob-e-Tac Adhesive.
- C. When you like the look you have created, mist lightly with Scenic Cement to hold the Turf in place.

Flyspecking with Turf

Dirt and soil collect in many areas, including on rock faces. Dirt and soil on rock faces may be indicated with a technique called Flyspecking.

Mist the Rock castings with "wet water" (6 oz. of water with a few drops of liquid soap added). Bend a sheet of paper into an "L" or "J" shape. Place a small amount of Soil Turf on the horizontal section of the paper. This will blow specks of Soil onto the rock castings (Fig. 78). If the area now has too much Soil, allow it to dry and brush it off with a dry paintbrush. To attach

permanently, mist with Scenic Cement from 18" to 24" away, gradually moving closer. If you place buildings on your layout, you will want them to appear to be settled-in rather than stuck-on. Follow the methods mentioned previously to add Coarse Turf and Clump-Foliage around the base of buildings to "ground" them to the layout.



A Final Word

You have now finished the Scenic Ridge Lightweight Layout Kit. Feel free to go back and fix any areas that don't meet your satisfaction. You can patch up your Road System or add extra foliage to cover gaps and seams around the Tunnel Portals or Culverts. You can even purchase more Woodland Scenics Trees, Rock Faces, Trackside Scenes or anything else that will personalize your Scenic Ridge Kit. You may even want to add a few DPM buildings. In the process of building Scenic Ridge you have also learned how to use the revolutionary Woodland Scenics SubTerrain Lightweight Layout System. This system allows you to add elevations, inclines and lowlands to your layout without using expensive power tools or complicated calculations. If you want to build future layouts with this system, ask your local hobby store for information. To learn more about the SubTerrain System, buy the "SubTerrain Video" (ST1401) and the "SubTerrain How-To Book" (ST1402). To learn more about landscaping your layout, purchase "The Scenery Manual" (C1207) and "The Clinic Video" (R990). Look through the catalog included with Scenic Ridge to find out more about our other incredible products.

NTRAK

NTRAK is a modular model railroad club with branches all over the United States. They have standardized track placement and other requirements so club members' N-scale modules can be connected together easily. If you want specifications for building Scenic Ridge as an NTRAK module contact them at: NTRAK, 1150 Wine Country Place, Templeton, CA 93465.

Products

Below is the list of Woodland Scenics' products used to construct Scenic Ridge. If you would like to build a new layout or add landscaping to your Scenic Ridge layout, just refer to the item name and number then go to your favorite hobby store and buy what you need. Woodland Scenics complete systems make it easy.

Item Number Description

SubTerrain Items

ST1408	2" Riser - 4/pkg
ST1411	4% Incline Set
ST1419	8" Profile Boards
ST1422	1/4" Foam Sheet
ST1423	1/2" Foam Sheet
ST1431	Foam Pencils
ST1432	Foam Nails - 2"
ST1444	Foam Tack Glue
ST1452	Smooth-It
ST1453	Top Coat Asphalt - 4 fl. oz.
ST1454	Top Coat Concrete - 4 fl. oz.
ST1455	Paving Tape
ST1472	N-scale Track-Bed - 12/pkg

Landscaping System items

B74	Light Gray - Fine Ballast
FC182	Light Green - Clump-Foliage
FC183	Medium Green - Clump-Foliage
FC184	Dark Green - Clump-Foliage
FG172	Harvest Gold - Field Grass
T41	Soil - Fine Turf
T42	Earth - Fine Turf
T43	Yellow Grass - Fine Turf
T44	Burnt Grass - Fine Turf
T49	Green Blend - Blended Turf
T64	Medium Green - Coarse Turf
S191	Scenic Cement
S192	Scenic Sprayer
S195	Hob-e-Tac Adhesive

Terrain System Items

C1153	N-scale Cut Stone Portals
C1162	N-scale Concrete Culverts
C1201	Lightweight Hydrocal
C1203	Plaster Cloth
C1220	Black - Earth Colors Liquid Pigment
C1222	Burnt Umber - Earth Colors Liquid Pigment
C1223	Yellow Ocher - Earth Colors Liquid Pigment
C1229	Earth Undercoat - Earth Colors Liquid Pigment
C1234	Random Rock Mold
C1243	Base Rock Mold
C1282	Natural - Fine Talus

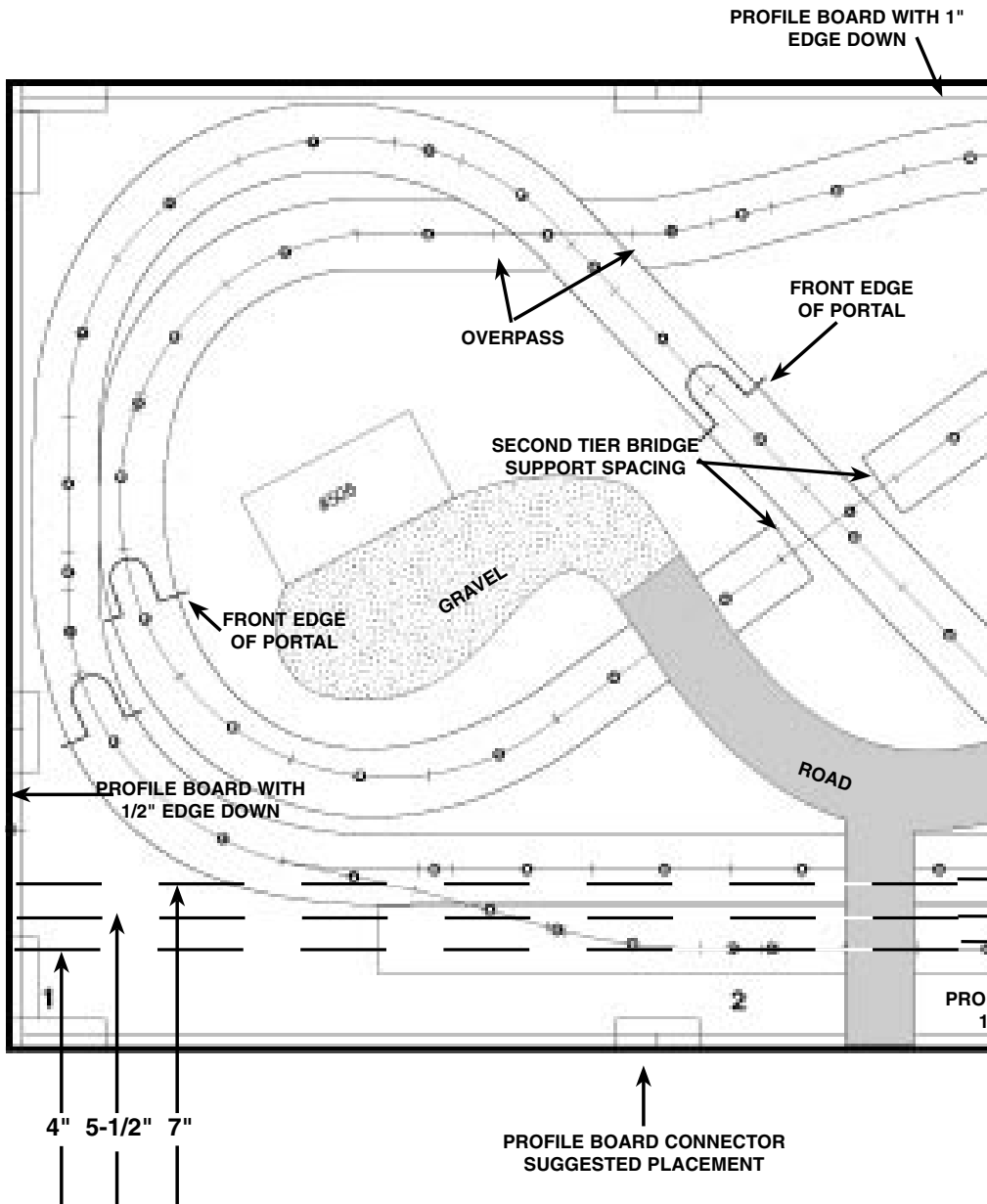

NTRAK MEASUREMENTS FROM DOTTED LINE TO FRONT OF LAYOUT

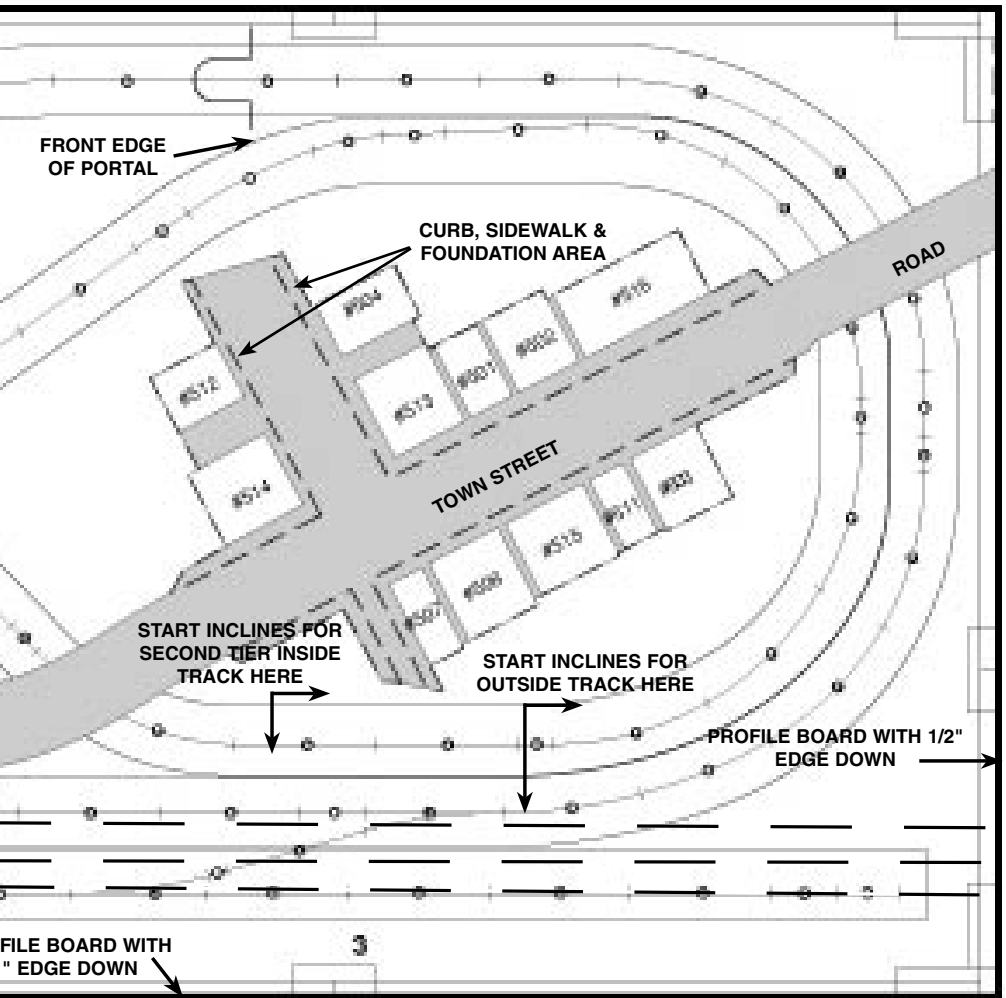

WOODLAND SCENICS SCENIC RIDGE LAYOUT ATLAS N SCALE SNAP-TRACK

A = 5" STRAIGHT..... 33	G = 19" RADIUS..... 5
B = 2 1/2" STRAIGHT 8	H = 1/2 - 9 3/4" RADIUS..... 2
C = 1 1/4" STRAIGHT 6	I = 1/2 - 11" RADIUS 3
D = 5/8" STRAIGHT 4	J = LEFT TURNOUT SWITCH 3
E = 9 3/4" RADIUS 14	K = BUMPER 1
F = 11" RADIUS.....11	L = BRIDGE 1

WOODLAND SCENICS®
PO Box 98 • Linn Creek, MO 65052
www.woodlandscenics.com
XINSTST1482 Y3 ©1999 OCO