



Kit Contents: 6 Walls, 8 Windows, 1 sheet Clear Window Material, 1 sheet Roof Material, 1 sheet Decal, 3 sections Brick Wall Trim, 2 Roof Vents, 14 Pilasters, 2 Doors, 2 Planning Sheets, Instructions

MODULAR LEARNING KIT 36000

The Modular Building System™ has more than 40 interchangeable plastic Wall Sections. The interchangeable design allows for the creation of structures in any shape or size.

The Learning Kit teaches basic techniques for building with Modular Wall Sections and parts. At the end of the instructions, you will find information about using the Modular System to build virtually any structure.

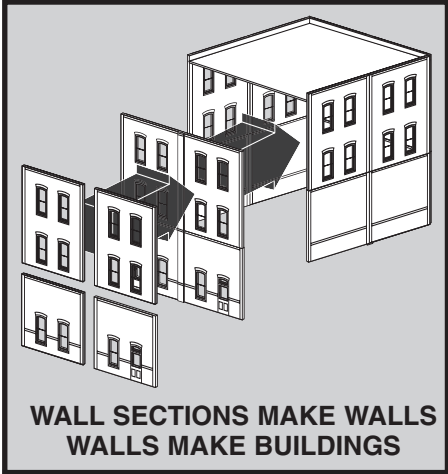

**WALL SECTIONS MAKE WALLS
WALLS MAKE BUILDINGS**

**INSTRUCTION OVERVIEW
AND MODELING TIPS**

Wall Sections are glued together horizontally with Pilasters to form Wall Panels (Fig. 1-3 and 7). For this kit, the Front and Back Wall Panels are two Wall Sections wide, and the Side Wall Panels are one Wall Section wide (Fig. 4 and 5).

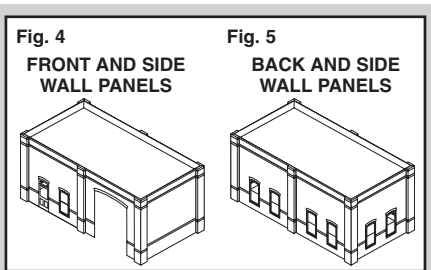
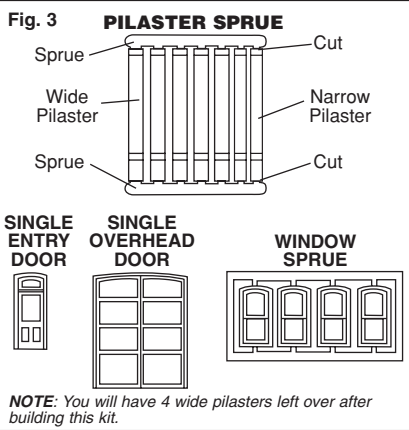
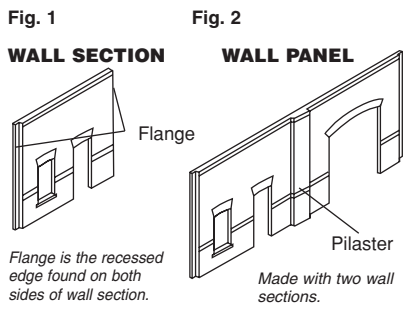

Leave parts attached to sprue until ready to use (Fig. 3). Use a hobby knife or flush cutting shears to remove parts from sprue. To prepare parts for assembly, excess plastic (flash and tabs) that occurred during the molding process will need to be removed (Fig. 6). Use a hobby knife and sandpaper to remove and sand smooth.

Use model glue or solvent-based plastic cement to assemble parts. Avoid contact with detail on parts and visible areas of Clear Window Material. Always allow glue to set completely before moving on to the next construction step.

We suggest using a squaring block (2" x 2" x 10" block) when sanding Walls and during assembly to form corners. Hold sanding block firmly in place and keep stationary while sanding (Fig. 11-13).

INSTRUCTIONS

MODULAR WALL BUILDING TECHNIQUES

Read through instructions completely before beginning. Becoming familiar with the building techniques ahead of time makes the kit easier to build and more fun.

Prepare Parts and Assembly

1. Wash parts in warm, soapy water using a mild detergent. Rinse and let dry.
2. Prepare Wall Sections and Pilasters for assembly. Use a hobby knife and/or sandpaper to remove excess plastic (flash, tabs, sprue and nubs). Use a hobby knife or flush cutting shears to remove tabs and parts from sprue (Fig. 3 and Fig. 6). **Flash:** Lightly scrape along edges to remove debris, then sand smooth. Face cutting edge of blade opposite the scraping direction to not cut into the part. **Nubs:** Sand off nubs so Pilasters lay flat on Wall Sections. **Tabs and Sprue:** Score flush with part, snap off and sand smooth. Sand parting lines and mold flash. Keep parts on sprue until ready to use.

NOTE: Do not sand detailed edge of Pilasters.

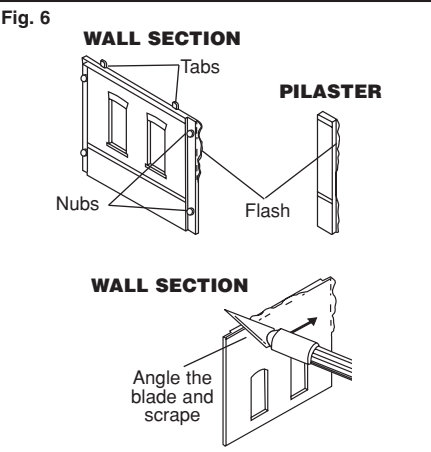

Wall Panel Assembly (Fig. 4 and 5)

3. Place Wall Sections side-by-side (face up) horizontally (Fig. 7). Keep glue off brick detail on Wall Sections and Pilasters by applying glue along outer edge of flanges (Fig. 7 inset). To help keep Wall Sections level, place a 1/8" thick straightedge along top of Wall Section edges (Fig. 7). Fit Pilasters snugly into recessed area between wall sections (Fig. 8). Do not attach Pilasters to outer edges of Wall Panels until next step. Allow glue to set before moving on to next construction step.

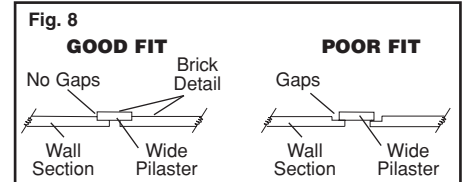
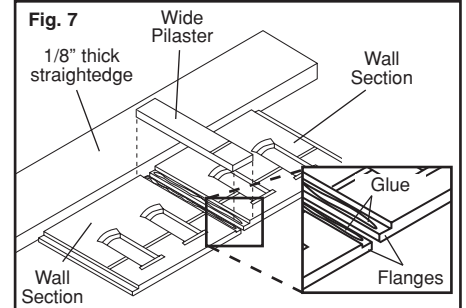

4. Attach Wide Pilasters to outer edges of Front and Back Wall Panels. Attach Narrow Pilasters to outer edges of Side Wall Sections (Fig. 10). Narrow Pilasters have brick detail on one edge and are smooth on the other. Smooth texture should face away from Wall Section. Wide and Narrow Pilasters will meet at building corners and appear to be equal width on both sides when placed correctly (Fig. 9).

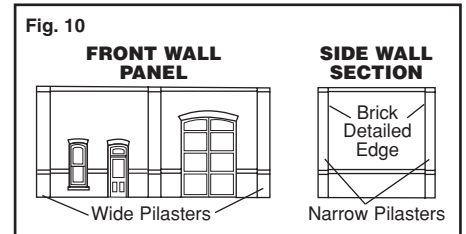
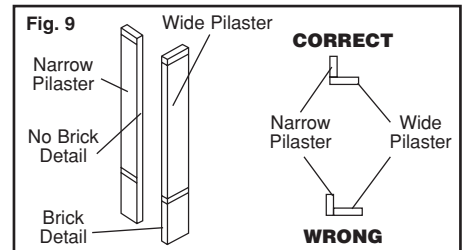

Building Assembly

1. Tack 120-grit sandpaper to a flat surface. Make sanding area longer than longest wall panel (Fig. 11).

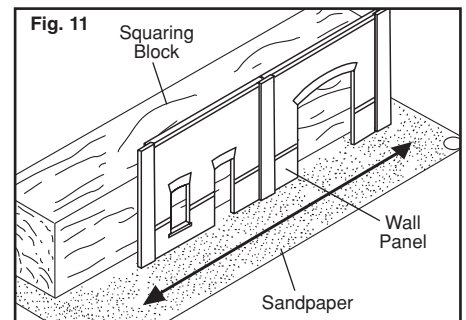

- Sand top and bottom edges of Wall Panels and Wall Sections to even out any slight height variations between Walls and Pilasters and level beveled edges (slight angles needed to eject some parts from mold). Do not sand into detail. Keep edges flat on sandpaper so no rounding occurs (**Fig. 11**).
- Do not sand edges of Wide Pilasters on Front and Back Wall Panels.
- Sand outer edges of Narrow Pilasters on Side Walls just enough to remove bevels (**Fig. 12**).

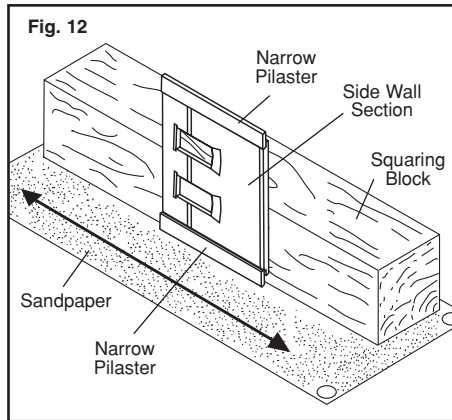

- Glue Side Wall Sections to Back Wall Panel. Glue smooth edge on Narrow Pilaster to smooth backside of Wide Pilaster (**Fig. 9**). Use squaring block to ensure square corners (**Fig. 13**). Glue Front Wall Panel to Side Wall Sections to form three-dimensional building (**Fig. 13**).

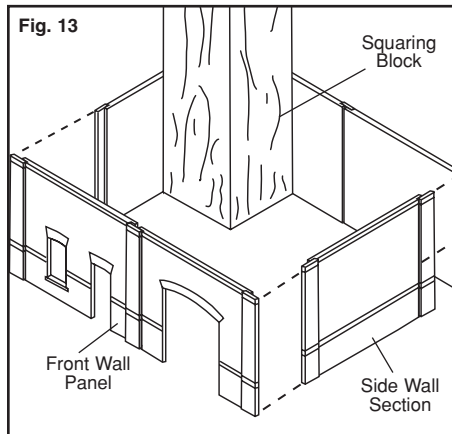

- When glue is set, turn building upside down and place on Roof Material (white styrene sheet). Trace roof opening along inside of walls. Set Roof Material aside for later use.
- Cut the Brick Wall Trim strips to fit around the interior Walls along the top of the building (**Fig. 14**). This creates a decorative parapet. Sand cut ends lightly. Make sure to not round edges. Glue in place, aligning the top edge of Brick Wall Trim flush with top edge of Walls (**Fig. 14**). Position Brick Trim so vertical brick pattern faces up.

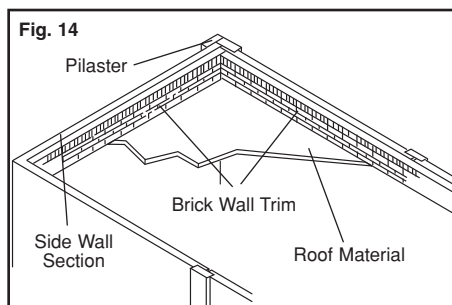

PAINTING

Building appearance is enhanced by painting. Colors are your choice. We suggest natural brick colors such as rust or other earth tones for the building. Windows and doors can be the same color or a color complimentary to the brick.

Airbrush or Hand-brush Use flat finish acrylic or enamel paint.

Aerosol Use flat finish spray paint.

- Paint building, including Brick Wall Trim.
- Paint Window Frames, Entry Door and Overhead Door while on sprue.
- Weather building to make it look aged. See "Weathering."
- Scrape paint from surfaces yet to be glued.

WEATHERING

Weathering Wash: Using a paintbrush, dab on small amounts of wash (formula follows) until desired look is achieved. Sponge off excess.

Formula: Mix 1-part acrylic paint (color suggestion: concrete or aged concrete), 12-parts rubbing alcohol, 8 parts water and 1 drop liquid dish soap.

Airbrush: Lightly spray thinned flat black acrylic paint (color suggestion: grimy black) to areas where natural discoloration can occur (near windows, chimneys, etc.).

Chalk: Rub a dark color of pastel chalk (color suggestion: gray, black, brown, etc.) on sandpaper to create a chalk dust. Using a paintbrush, dab chalk dust where discoloration can occur.

DRY TRANSFER DECALS (Fig. 15)

We suggest applying the thermometer decal to excess plastic from Roof Material. Trim to fit and glue to Front Wall. Apply "Notice" and "Mechanic" signs to Overhead Door. Use "Office" and "Open" decals as window signs, applied according to directions under "Windows and Doors." Apply all other Decals directly to Brick.

- Apply Decals to clean, dust-free surface only. Keep decal sheet clean and dust-free.
- Cut out Decal, leaving a slight edge. Remove backing paper. Grasp with tweezers and avoid handling the back.
- Position Decal and rub entire backside with a burnisher or dull pencil. Do not press too hard. Lift carrier sheet slowly, if Decal did not transfer completely let carrier sheet fall back in place and reburnish. Replace backing paper over Decal and burnish again.
- If applying Decal directly to brick, press into mortar joint crevices using soft eraser.

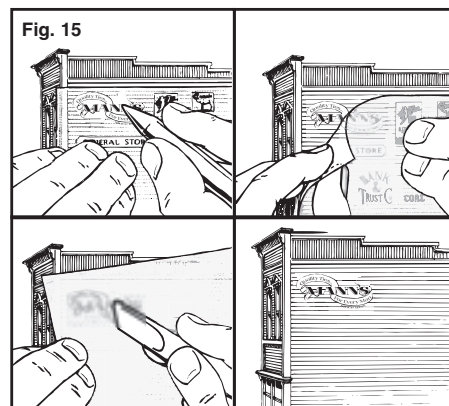

WINDOWS AND DOORS

- When paint is dry, remove Window Frames from sprues. Touch up paint, if necessary.
- To use Dry Transfer Decals as window signs, apply Decal to Clear Window Material as instructed. Center Window Frames over Decal where desired and trace outside edge of Window Frame. Cut out Window Material just inside cutline.
- Cut Window Material to size and center on backside of Window Frame. Apply a tiny amount of glue around edges. Be careful to not get glue on visible area of Window Material.
- Glue Windows and Doors to building, taking care to keep glue from getting onto detail. Insert from inside building.

ROOF

- Cut out Roof around the tracing made earlier and test fit. Adjust size with hobby knife, if necessary.
- Paint top of roof flat black.
- From underneath building, glue roof to bottom of Brick Wall Trim strips (**Fig. 14**).
- Paint Roof Details with flat-finish paint. Glue in place.

DISCOVER THE UNLIMITED OPTIONS

There are two ways to purchase modular parts - Designer Bulk Packs and individual wall section packages. Designer Bulk Packs contain all the modular parts to complete one of the three building designs included, plus styrene plastic roof material, clear window material and roof details. Each Pack is based on one of the five architectural styles represented in the Modular System: Arched Window, Rectangular Window, Steel Sash Window, Victorian Storefront and 20th Century Storefront.

In addition to offering specific designs, these Bulk Packs provide an economical way to purchase modular parts for your own designs. The possibilities for size and shape are virtually limitless when you combine Designer Bulk Packs with more than 40 interchangeable wall sections in the Modular System.

Individual wall section packages each contain 4 identical wall sections, the pilasters needed to join them and/or doors, windows and clear window material. Cornice packages and Dock Riser packages each contain 8 sections plus pilasters. Powerhouse window packages contain 2 two-story windows and 4 wall sections. The Roof and Trim Kit (#30190) includes materials to make a roof of your own design and add details.

When you create your own design, use the enclosed Planning Packet (#30191). It contains full-sized drawings of all modular wall sections. Make several photocopies of drawings, cut out and arrange individual paper wall sections to mock up entire walls. Overlap the 1/4" pilasters along side edges of sections. Tape together. Then tape or glue entire walls on cardboard, cut around entire walls and tape or glue together to form a three-dimensional mock-up. Count the quantity of each wall section style used in the mock-up to determine which modular parts to purchase.

Find the entire HO scale Modular System at your local hobby shop and visit woodlandscenics.com for more information, how-to videos and modeling tips and techniques.

WOODLAND SCENICS®
 Manufactured by **WOODLAND®**
 PO BOX 98, LINN CREEK, MO 65052
woodlandscenics.com

DPM® LANDMARK STRUCTURES® HO SCALE MODULAR WALL SYSTEM

PLANNING PACKET 30191



Refer to enclosed instruction sheet to familiarize yourself with the system. All wall sections are reproduced full size on both sides of this sheet. Make multiple copies on a photocopy machine, cut out wall sections and glue onto cardstock. When cutting out wall sections, leave a "glue tab" above each piece to glue to an upper story or cornice. The gray edges on the wall sections represent where you should attach pilasters. The true edges of the wall section are indicated by the dotted lines in the gray areas. Align pilasters vertically to make a single pilaster between walls. When aligning pilasters, overlap the pilaster of one wall section over the pilaster of another wall section. An entire structure can be built in this manner. You will know in advance exactly how it will look on your layout and which part to purchase.

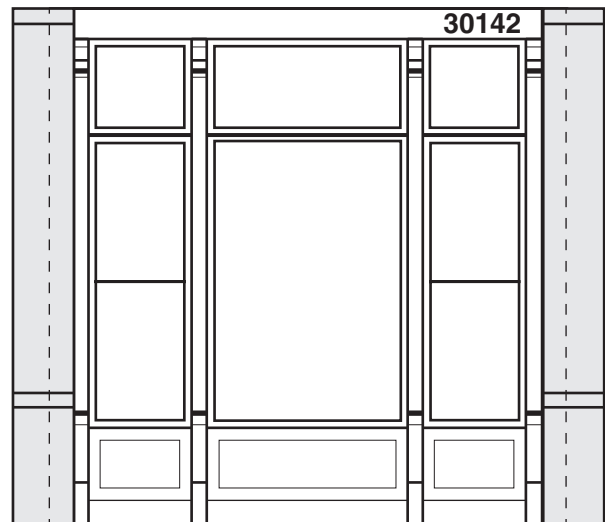
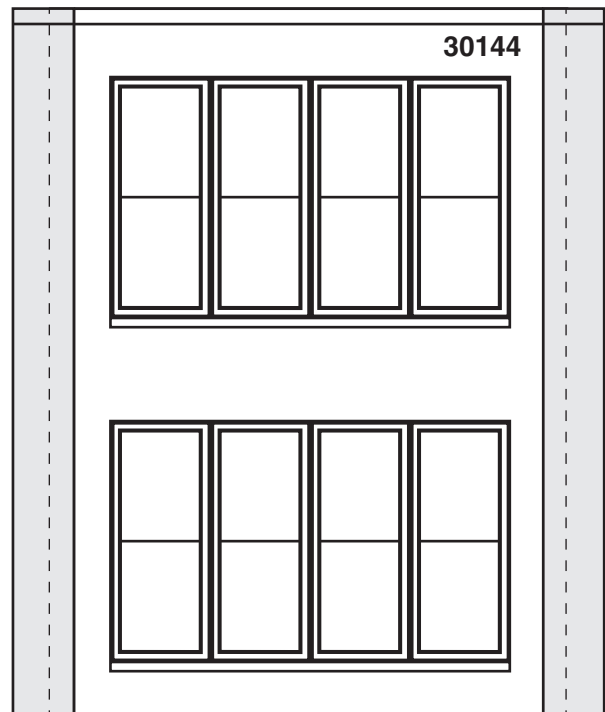
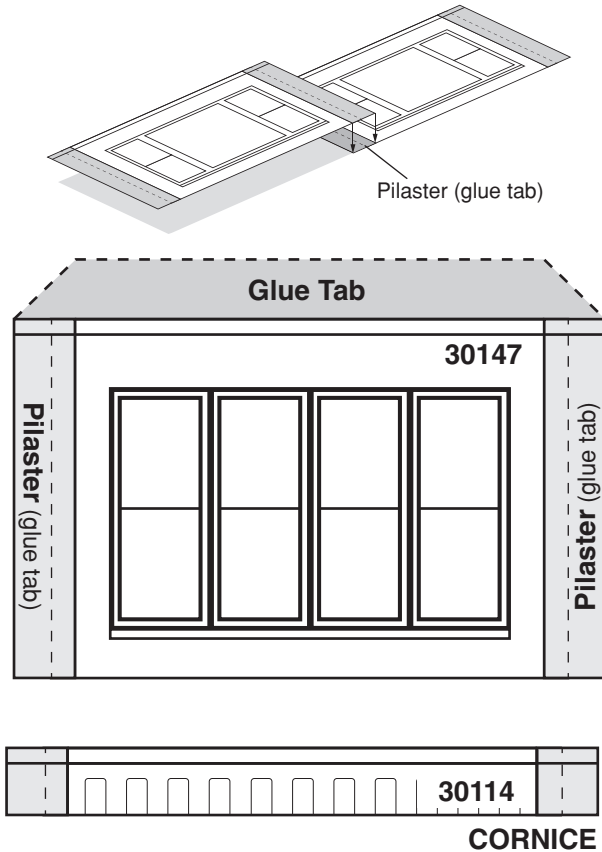

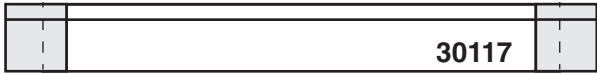

30117

CORNICE



30115

DOCK RISER

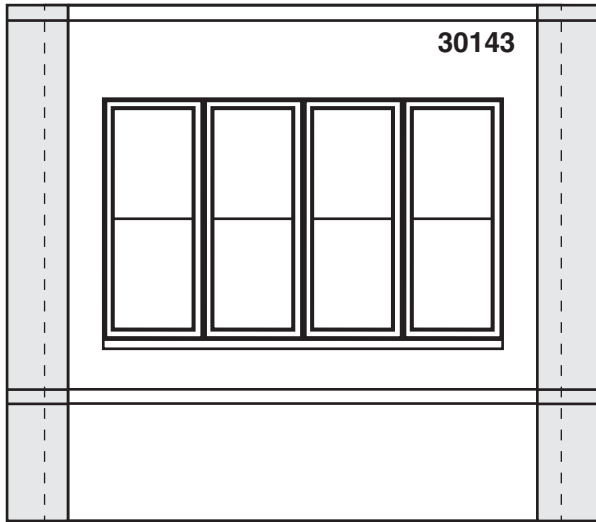

30143

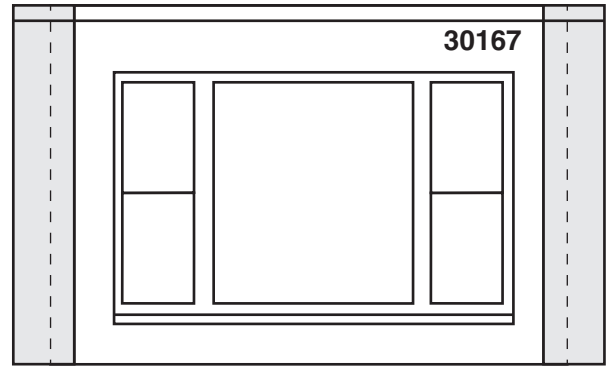

30167

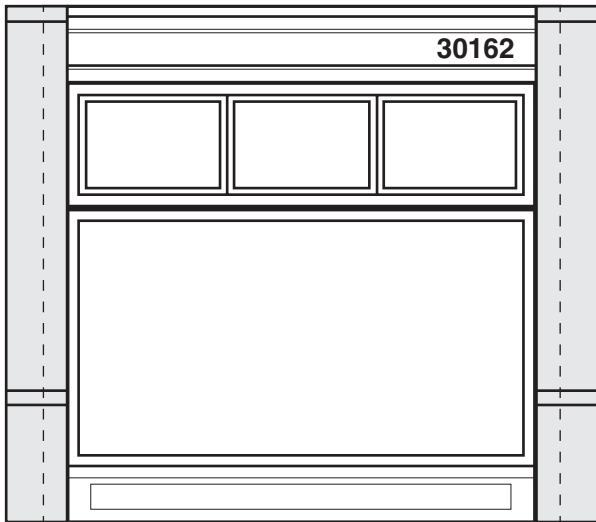

30162

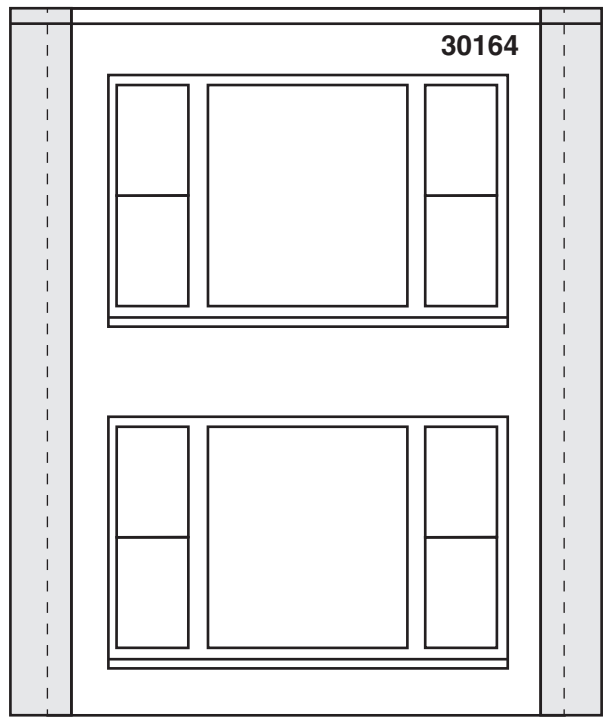

30164

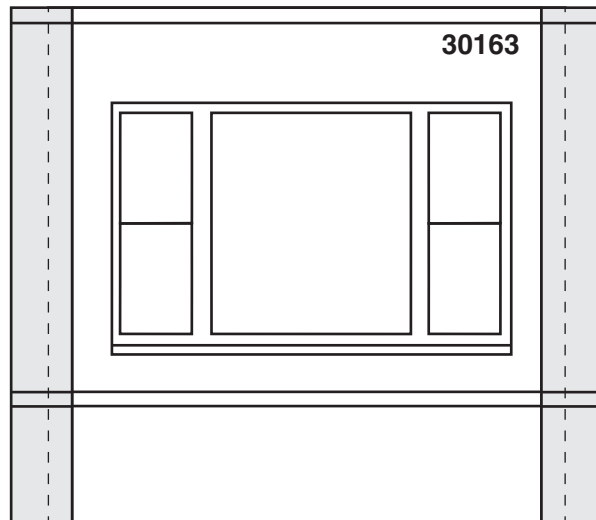

30163



30161

