

# **MOD-U-RAIL<sup>®</sup>** **SYSTEM**

## **INSTRUCTION BOOKLET FOR**

### **Straight Module Kit (ST4801)**

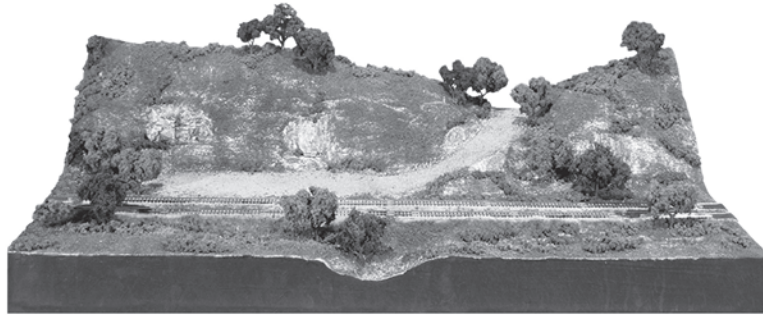

### **Corner Module Kit (ST4802)**

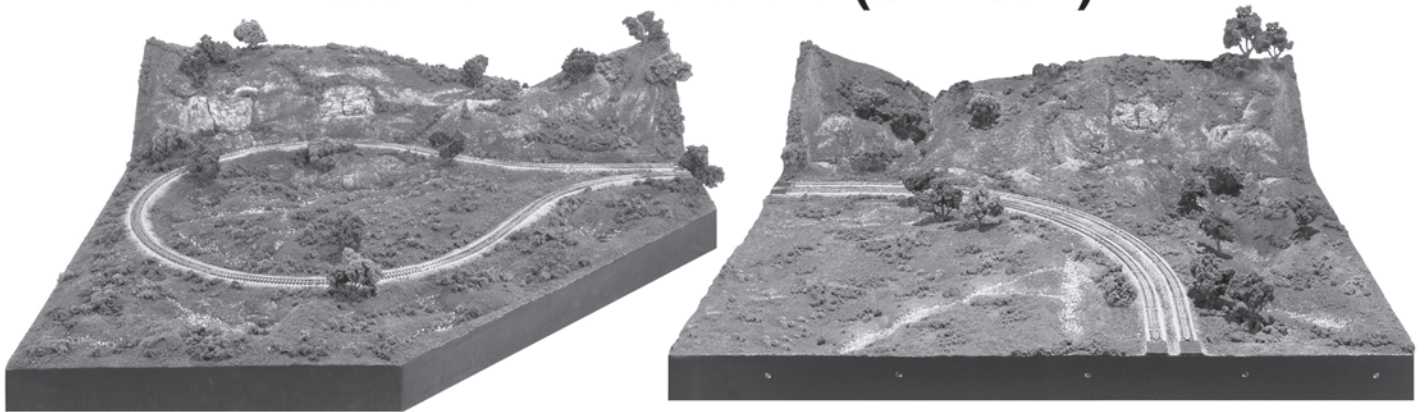

Great for N or HO  
adapts to S, Z and O scales



**WOODLAND SCENICS<sup>®</sup>**

# Table of Contents

<b>INTRODUCTION</b> .....	<b>2</b>	PLASTER CLOTH LAYOUT.....	15
BEFORE YOU START .....	2	<b>TRACK-BED, TRACK, WIRING AND PLASTER CLOTH SIDES</b>	<b>16</b>
ROOM LAYOUT AND DESIGN .....	3	INSTALL TRACK-BED .....	16
ENDLESS POSSIBILITIES .....	3	INSTALL TRACK AND WIRING .....	16
TRACK PLAN.....	3	PLASTER CLOTH SIDES.....	16
STRAIGHT MODULE KIT CONTENTS .....	4	<b>TERRAIN</b> .....	<b>17</b>
CORNER MODULE KIT CONTENTS.....	4	INSTALL ROCKS .....	17
ADDITIONAL ITEMS NEEDED.....	4	COLOR ROCKS.....	17
TRACK .....	5	APPLY EARTH UNDERCOAT .....	17
ADHESIVES AND TOOLS .....	5	BALLAST TRACK .....	17
MODULE OVERVIEW.....	5	<b>LANDSCAPE</b> .....	<b>18</b>
BASIC REQUIREMENTS.....	6	MAKE TREES .....	18
<b>STRAIGHT MODULE KIT</b> .....	<b>6</b>	APPLY LOW GROUND COVER.....	18
BASE PREPARATION.....	6	APPLY MEDIUM GROUND COVER.....	18
TEST-FIT TRACK.....	7	ATTACH TREES.....	19
MARK AND CUT PROFILE BOARDS .....	7	<b>FINISH MODULE</b> .....	<b>19</b>
INSTALL PROFILE BOARDS .....	8	PAINT SIDES OF MODULE.....	19
ATTACH CONNECTOR PLATES.....	8	CONNECT MODULES.....	19
INSTALL RISERS.....	8	<b>ADD ADDITIONAL FEATURES</b> .....	<b>20</b>
CUT CONTOURS.....	9	ADD UNIQUE FEATURES TO YOUR LAYOUT .....	20
OPEN BOLT HOLES.....	9	ADD PROFILE BOARDS .....	20
CUT ACCESS HOLES .....	9	ADD ELEVATION/GRADES.....	20
<b>CREATE CONTOURS AND APPLY PLASTER CLOTH</b> .....	<b>10</b>	OVERPASSES .....	20
ADD PAPER WADS .....	10	TUNNELS.....	20
ADD PLASTER CLOTH TO RISERS.....	10	BRIDGES .....	21
PLASTER CLOTH LAYOUT.....	10	MAKE FLAT, LEVEL AREAS.....	21
<b>CORNER MODULE KIT</b> .....	<b>11</b>	ADD RETAINING WALLS OR CULVERTS.....	21
BASE PREPARATION.....	11	CONNECTOR PLATE SET .....	21
TEST-FIT TRACK.....	11	<b>HO SCALE TRACK PLANS</b> .....	<b>22</b>
MARK AND CUT PROFILE BOARDS .....	12	<b>N SCALE TRACK PLANS</b> .....	<b>23</b>
INSTALL PROFILE BOARDS .....	12	<b>TEMPLATE USAGE</b> .....	<b>24</b>
ATTACH CONNECTOR PLATES.....	13	HOW TO USE THE TEMPLATES.....	24
INSTALL RISERS.....	13	ADD FEATURES.....	24
CUT CONTOURS.....	14	<b>LAYOUT DESIGN SHEET</b> .....	<b>25</b>
OPEN BOLT HOLES.....	14	<b>NOTES</b> .....	<b>26</b>
CUT ACCESS HOLES .....	14	<b>GRID</b> .....	<b>27</b>
<b>CREATE CONTOURS AND APPLY PLASTER CLOTH</b> .....	<b>15</b>		
ADD PAPER WADS .....	15		
ADD PLASTER CLOTH TO RISERS.....	15		

## Introduction

The Woodland Scenics Mod-U-Rail System gives you the freedom and convenience to build the layout of your dreams, one module at a time! The system consists of module kits that, when assembled, can be bolted together to create a layout of any size and in most any scale. Whether you are creating a layout for your home, starting a club or building a layout with friends, you can build it at your own pace.

This is a kit with all of the basics for building a module, but you are not limited to using just the materials in this kit. Woodland Scenics has a wide variety of SubTerrain, Terrain and Landscaping products for your layout. You can add details at any time to express your individuality. It makes no difference if you are a beginner or advanced craftsman. The kit goes together quickly and easily with expert results.

Be sure to read through the instructions prior to assembly. After you have built one module, you will have a clear understanding of how the system works. **These instructions are guidelines. In some cases it may be necessary to deviate from these instructions to create your dream layout.**

### Before you start, ask yourself some simple questions ...

1. What scale will you be modeling? Will you model a specific railroad?
2. What era will you model? Stay with that era for the most consistency and realism on your layout.
3. How far off the floor will your model railroad be? The normal height is 30"-50" high.
4. Are you using passenger cars, freight cars or both? Passenger and larger diesel cars require a larger radius for turns (Fig. 1).
5. Do you have sufficient lighting in your room and outlets for your train operation?
6. Will you form or join a club? **IMPORTANT:** When forming or joining a club, be sure to understand, or define, the club requirements for building and joining your modules together.

Fig. 1

SUGGESTED RADIUS		
	N	HO
Freight Car	11"	18-22"
Passenger Car and larger Diesel	19"	22-30"



## Room Layout and Design

You can design your own layout, or use the ones on page 22 or 23 in this instruction booklet. To design your own, remove the Grid and Layout Design Sheet from the back of this instruction booklet (pages 25 and 27). Begin by drawing your room size on the Grid (page 27). You may want to make copies and tape the copies together if your room size is larger. Be sure to consider your electrical outlets. Mark the doors (and the door sweep areas), windows, vents, closets, bathrooms, posts, etc. so that your Grid is an exact replica of your room (**Fig. 2**).

Cut out the patterns, ruler and templates from the Layout Design Sheet (page 25). You may want to make several copies of this sheet depending on the number of modules you will need to make your layout.

Now design your layout with the module patterns, moving them around to give you the best layout possible for your room. You can refer to books and magazines for ideas. Allow for mountainous areas, bridges, waterways, buildings and turnouts. Once you have planned your layout, glue or trace the module patterns onto the Grid (**Fig. 3**). Remember, modules can be customized to perfectly fit your room.

## Endless Possibilities

Below are several configurations that you can incorporate into your layout, it all depends on your track plan (**Fig. 4**). Use your imagination, the possibilities are endless. Build your layout as small or as large as you like! There are no complicated calculations, no dusty mess and you won't make a mistake that you can't fix.

## Track Plan

There are sample track plans on pages 22 and 23, or you can design your own track plan using the templates, along with the ruler, as needed. Refer to page 24 to learn how to use templates.

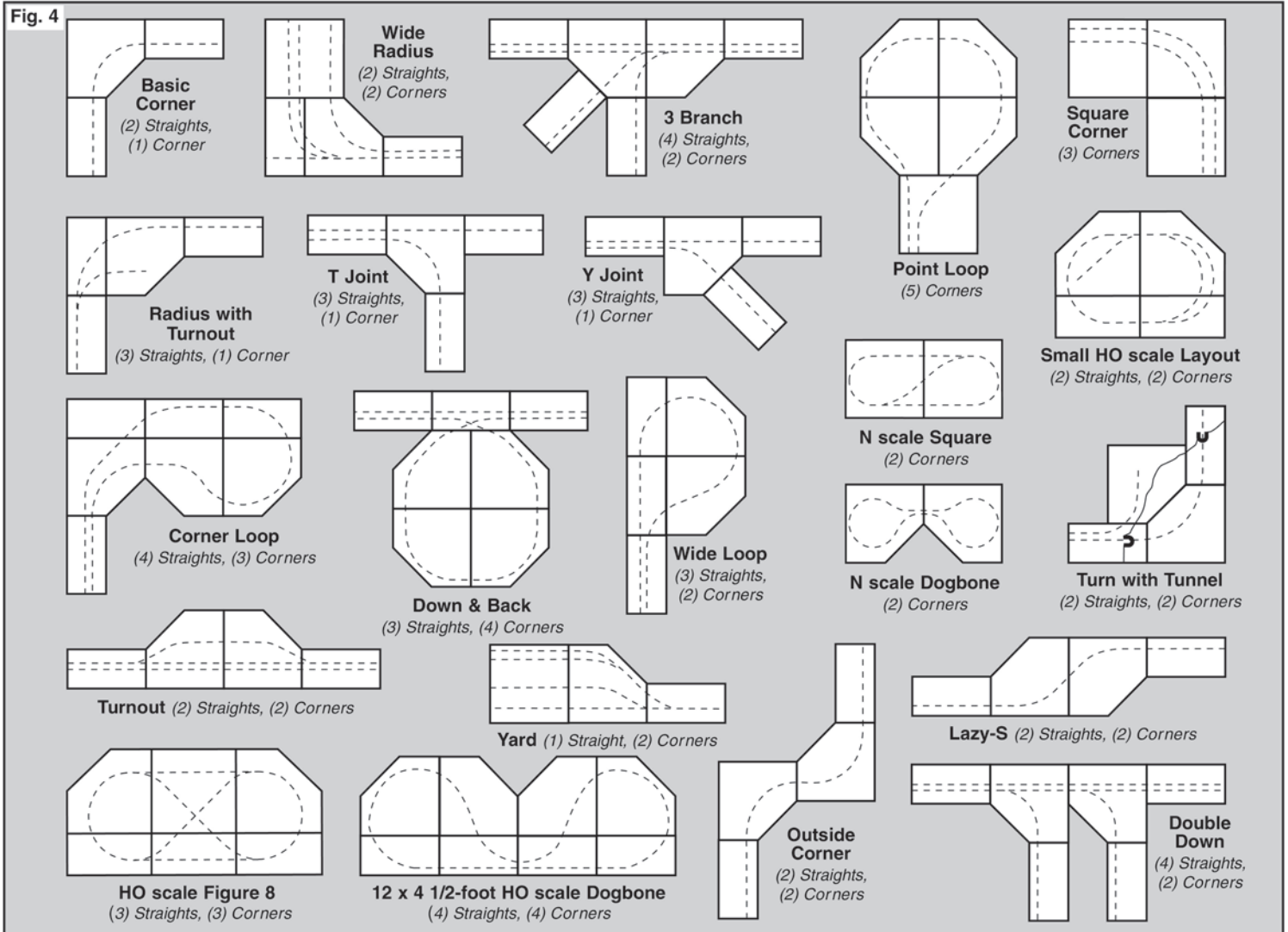
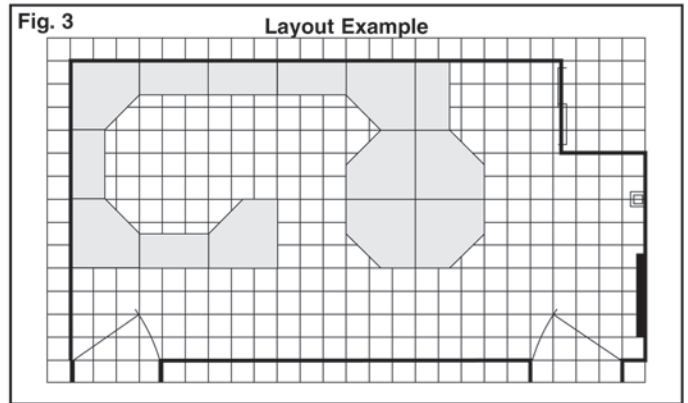
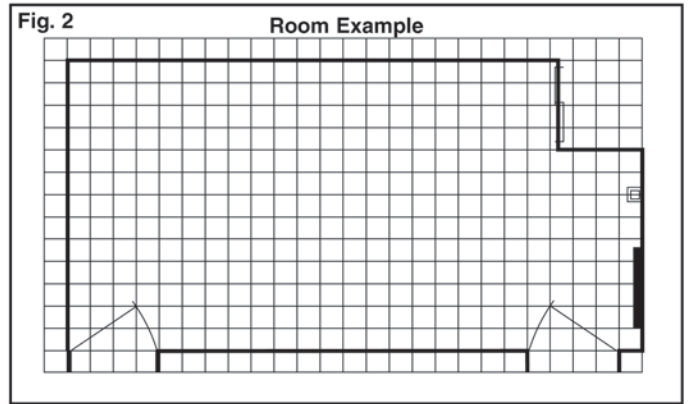

## Straight Module Kit Contents

### DESCRIPTION

- 3 Risers 2" x 24" (5.08 x 60.9 cm) ea
- 3 HO Scale Track-Bed™ Strips 24" (60.9 cm) ea
- 3 N Scale Track-Bed Strips 24" (60.9 cm) ea
- 1 Foam Base 1/2" x 18" x 36" (1.27 cm x 45.7 cm x 91.4 cm)
- 4 Profile Boards™ 8" x 24" (20.3 cm x 60.9 cm) ea
- 2 Connector Plates
- 3 Bolts
- 3 Wing Nuts
- 1 Plaster Cloth Roll 8" x 30', 20 ft² (20.3 cm x 914 cm, 1.85 m²)
- 1 Plaster Cloth Roll 8" x 7.5', 5 ft² (20.3 cm x 228 cm, 46.4 dm²)
- 4 Rock Castings
- 14 Tree Armatures
- 3 Earth Colors™ Liquid Pigment (Burnt Umber, Yellow Ocher, Black) 0.135 fl oz (3.99 mL) ea
- Earth Undercoat 1.84 fl oz (54.4 mL)
- Base Paint 1.84 fl oz (54.4 mL)
- Green Blend Blended Turf 21.6 in³ (353 cm³)
- Soil Fine Turf 3.6 in³ (58.9 cm³)

- Yellow Grass Fine Turf 3.6 in³ (58.9 cm³)
- Earth Fine Turf 3.6 in³ (58.9 cm³)
- Medium Green Coarse Turf 32.4 in³ (530 cm³)
- Light Green Clump-Foliage™ 34.2 in³ (560 cm³)
- Medium Green Clump-Foliage 50.5 in³ (827 cm³)
- Dark Green Clump-Foliage 16.2 in³ (265 cm³)
- Buff Fine Ballast (N scale) 10.8 in³ (176 cm³)
- Buff Medium Ballast (HO scale) 10.8 in³ (176 cm³)
- Brown Fine/Medium Grade Talus 3.6 in³ (58.9 cm³)
- Hob-e-Tac® 1 fl oz (29.5 mL)
- Foam Tack™ Glue 4 fl oz (118 mL)
- Scenic Glue™ 4 fl oz (118 mL)
- Scenic Cement™ 16 fl oz (473 mL)
- 1 Scenic Cement Spray Head
- 1 Plaster Cup and Sifter Lid
- 1 Foam Pad Applicator
- 2 Stir Sticks
- 1 Instruction Booklet

## Corner Module Kit Contents

### DESCRIPTION

- 4 Risers 2" x 24" (5.08 cm x 60.9 cm) ea
- 4 HO Scale Track-Bed Strips 24" (60.9 cm) ea
- 4 N Scale Track-Bed Strips 24" (60.9 cm) ea
- 2 Foam Bases 1/2" x 18" x 36" (1.27 cm x 45.7 cm x 91.4 cm) ea
- 6 Profile Boards 8" x 24" (20.3 cm x 60.9 cm) ea
- 2 Connector Plates
- 3 Bolts
- 3 Wing Nuts
- 2 Plaster Cloth Rolls 8" x 30', 20 ft² (20.3 cm x 914 cm, 1.85 m²) ea
- 4 Rock Castings
- 14 Tree Armatures
- 3 Earth Colors Liquid Pigment (Burnt Umber, Yellow Ocher, Black) 0.135 fl oz (3.99 mL) ea
- Earth Undercoat 1.84 fl oz (54.4 mL)
- Base Paint 4 fl oz (118 mL)
- Green Blend Blended Turf 64.9 in³ (1.06 dm³)
- Soil Fine Turf 3.6 in³ (58.9 cm³)

- Yellow Grass Fine Turf 3.6 in³ (58.9 cm³)
- Earth Fine Turf 3.6 in³ (58.9 cm³)
- Medium Green Coarse Turf 32.4 in³ (530 cm³)
- Light Green Clump-Foliage 34.2 in³ (560 cm³)
- Medium Green Clump-Foliage 50.5 in³ (827 cm³)
- Dark Green Clump-Foliage 16.2 in³ (265 cm³)
- Buff Fine Ballast (N scale) 10.8 in³ (176 cm³)
- Buff Medium Ballast (HO scale) 10.8 in³ (176 cm³)
- Brown Fine/Medium Grade Talus 3.6 in³ (58.9 cm³)
- Hob-e-Tac 1 fl oz (29.5 mL)
- Foam Tack™ Glue 4 fl oz (118 mL)
- Scenic Glue 4 fl oz (118 mL)
- Scenic Cement 16 fl oz (473 mL)
- 1 Scenic Cement Spray Head
- 1 Plaster Cup and Sifter Lid
- 1 Foam Pad Applicator
- 2 Stir Sticks
- 1 Instruction Booklet

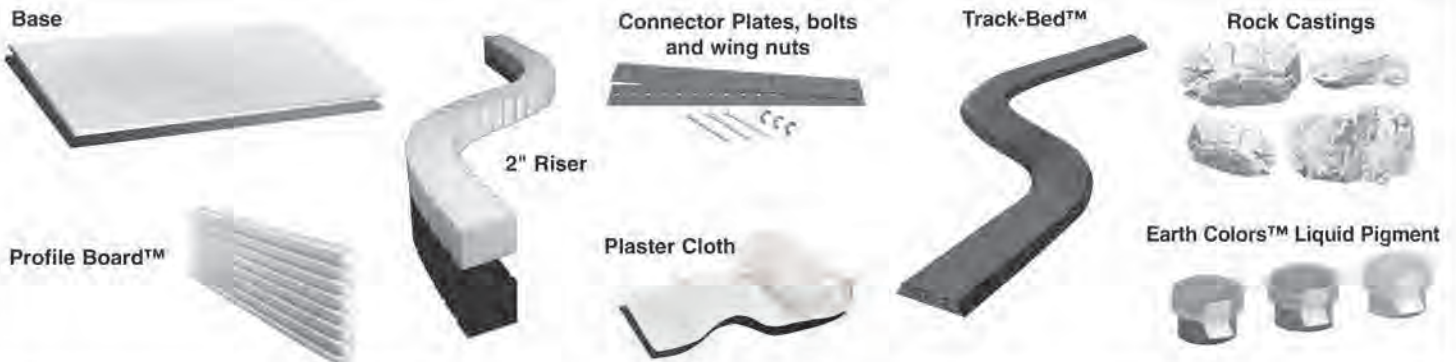

## Additional Items Needed

- 1" masking tape
- scissors
- No-News™ Paper (C1188) or newspaper
- liquid detergent
- disposable cups
- graduated measuring cup
- drinking straw or eyedropper
- pan or bowl for water
- paintbrush
- toothpicks or small nail
- track (see page 6)
- ruler or straightedge
- spray bottle (for water)
- hobby knife or Foam Knife (ST1433)
- pencil or Foam Pencil (ST1431)

## HIGHLY RECOMMENDED:

- Low Temp Foam Glue Gun (ST1445)
- Glue Sticks (ST1446)
- Hot Wire Foam Cutter (ST1435)
- Foam Nails (ST1432)



## Track

The brand, scale and type of track depends on your experience and track plan. After you have designed your track plan, go to your local hobby shop to obtain help in deciding what track to use. Some brands of track are Atlas, Kato and Bachmann.

## Adhesives and Tools

Woodland Scenics offers two different kinds of adhesives and foam cutters for your SubTerrain products. Each has advantages for different jobs. General instructions for using these products appear below. You can find these adhesives and tools at your local hobby shop.

### Foam Tack Glue

Foam Tack Glue (ST1444) is a specially formulated glue that is safe and easy to use with foam. Used properly, you can assemble this entire kit. Foam Tack Glue is especially helpful when gluing Track-Bed or thin pieces of foam. However, your work must remain pinned down with Foam Nails until the Foam Tack Glue is dry (about 12 hours).



Foam Tack Glue must be spread evenly over the surfaces being glued together, so you will have to unpin Risers and other components in order to apply the glue. When applied to both surfaces and allowed to dry for a short period of time, it acts like contact cement.

If using the Foam Tack Glue to secure the foam, follow these steps:

- Pin foam in place to test-fit.
- Remove the foam pieces individually and spread a thin layer of Foam Tack Glue on the contact surface of each foam piece and the area where it will be placed.
- Replace each foam piece and pin it firmly in place. Repeat for the entire module.

### Low Temp Foam Glue Gun and Glue Sticks: Highly Recommended

**IMPORTANT:** Do not use a high temperature glue gun on this kit. It will melt the foam components.

The Low Temp Foam Glue Gun and Glue Sticks will not melt or damage foam components. Glue bonds almost instantly and is inexpensive to use.



We recommend this product for gluing Risers, Profile Boards and Foam Sheets. It sets much faster than Foam Tack Glue and you will not have to disassemble your work to use it. To use the Low Temp Foam Glue Gun and Glue Sticks, run a continuous bead at the seam of the materials you are bonding, unless directed otherwise.

### Hot Wire Foam Cutter: Highly Recommended

The Hot Wire Foam Cutter was designed to be the easiest and fastest way to cut foam components. An accessory called the Foam Cutter Bow & Guide (ST1437) makes the Hot Wire Foam Cutter even more versatile. Replacement Wire (ST1436) is also available.



## Module Overview

Below is a chronological overview to give you an idea of the module assembly.

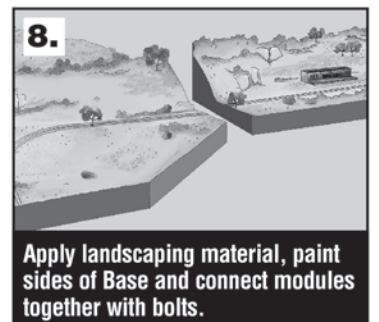
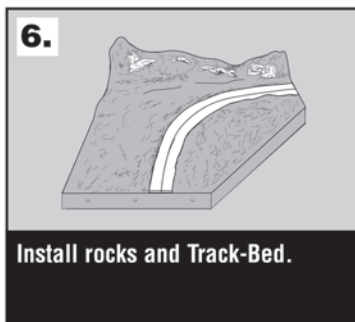
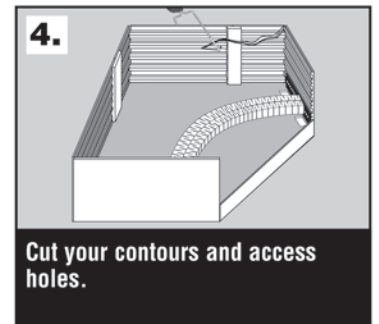
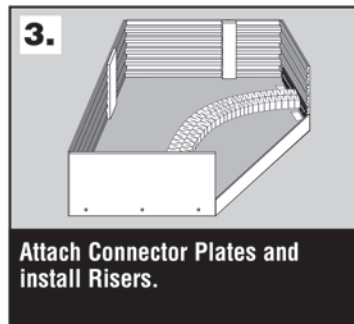
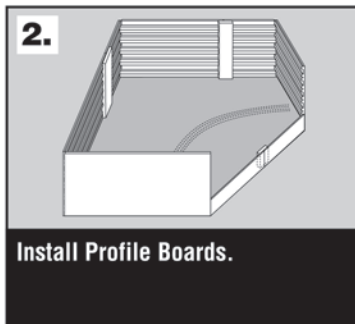
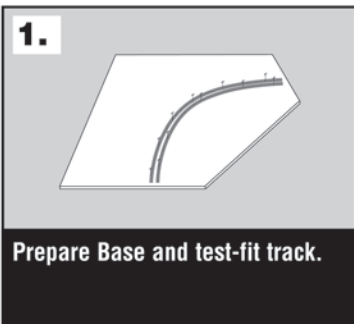

## Basic Requirements

To successfully utilize the Mod-U-Rail System, follow these three basic requirements when designing your track plan:

### 1. Track Placement From Edge

Make sure the track joints are set back from the edge of the module approximately 1 1/4" to 5" (depending on the scale and the particular track pieces available). This ensures a smooth train operation between modules, where another module's track joins it (Fig. 5). The brand of track you use (and the particular lengths of track available within that brand) determines this length, and it may be necessary to set the track back greater than 5".

**EXAMPLE:** If you are using Atlas N Scale Snap Track, you could set your track back 1 1/4" from the edge and use a 2 1/2" piece of track to connect the modules (1 1/4" spacing for each module). Or set your track back from the edge 2 1/2" and use a 5" piece of track (standard Atlas track sizes). Bachmann has 2 1/4" and 4 1/2" pieces. Kato also has various lengths of straight track and an Expansion Track piece that adjusts in length from 3" to 4 1/4". Flex Track can be cut to the length you need.

### 2. Duplicate Contours on Joining Modules

When building a new module to attach to an existing module or layout, make the new modules' contours exactly the same as the existing module's contours (Fig. 6).

### 3. Alignment of Modules

It is critical to keep the track height and distance from the front edge of module the same where modules will join. Test-fit Riser, Track-Bed and track on adjoining module for proper alignment (Fig. 7). Install Riser, Track-Bed and track. Attach the Connector Track piece to the finished module. Push the modules together and mark where the Connector Track piece and ballast ends on the Track-Bed (Fig. 8).

**NOTE:** Do not ballast the Connector Track piece if you belong to a module club or will be taking your modules apart regularly.

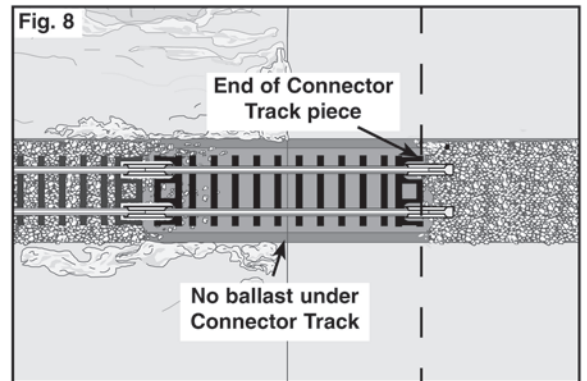
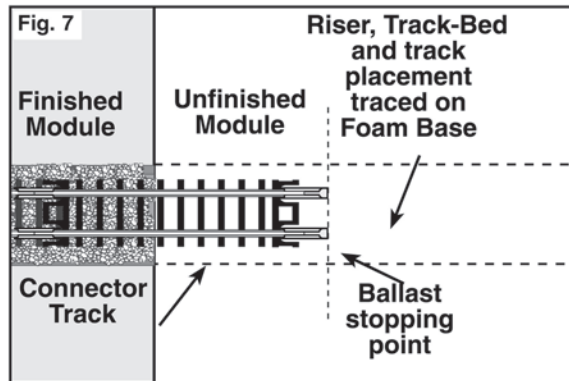
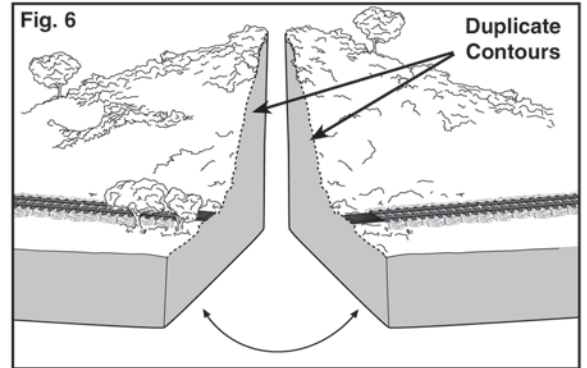
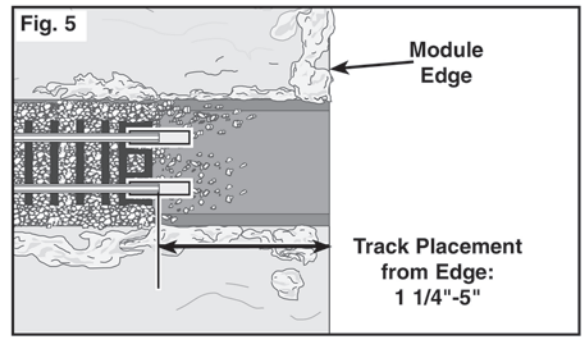

**NOTE: IF YOU ARE BUILDING THE STRAIGHT MODULE KIT (ST4801) BEGIN HERE. IF YOU ARE STARTING WITH THE CORNER MODULE KIT (ST4802) TURN TO PAGE 11.**

## Straight Module Kit

### Base Preparation

The following instructions are planned for the Base to be 36" x 18". The length of the Base can be trimmed as needed in order to accommodate your track plan. Use a pencil or Foam Pencil to trace your track plan on the Base (Fig. 9).

#### Items Needed

- Base
- Pencil or Foam Pencil
- Ruler or straightedge

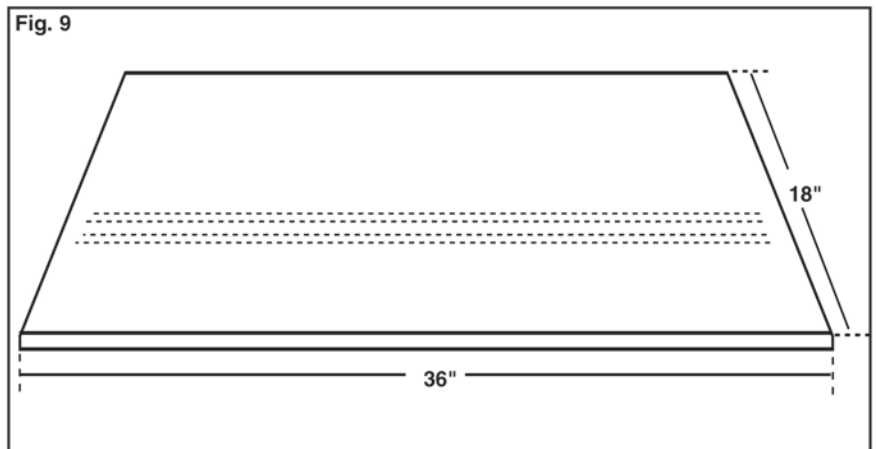

## Test-Fit Track

Assemble your track on the Base according to the track plan you've designed (**Fig. 10**). Pin the track in place with Foam Nails. At this point, you will need to decide if you want rivers, streams or other water areas. You will need to plan for them, and for the installation of tunnels or bridges. After you have placed your track, make markings on the Base where you would like these features. Remember the "Track Placement From Edge" requirement (pg. 6). Remove the pins and track and set aside.

**Items Needed**

- Track
- Base
- Foam Nails
- Pencil or Foam Pencil

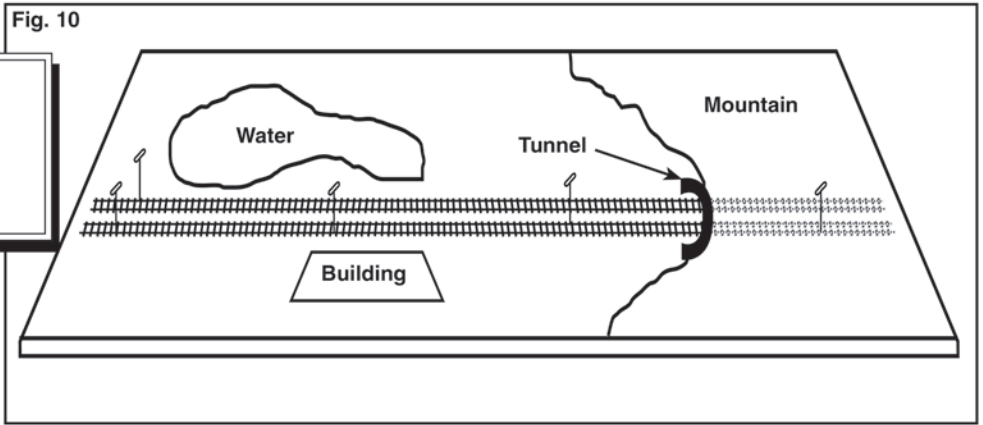

## Mark and Cut Profile Boards

Profile Boards are ribbed, 8" x 24" interlocking components with a 1/2" thickness on one edge and a 1" thickness on the other. They create the perimeter of your module. This module kit contains enough materials for an 8" contour height on the back, right and left profiles (**Fig. 11**). Mark the four Profile Boards as shown (**Fig. 12**). Then cut the pieces out using Woodland Scenics Hot Wire Foam Cutter, Foam Knife or hobby knife.

**Items Needed**

- Profile Boards
- Foam Knife, Hot Wire Foam Cutter or hobby knife
- Ruler or straightedge
- Pencil or Foam Pencil

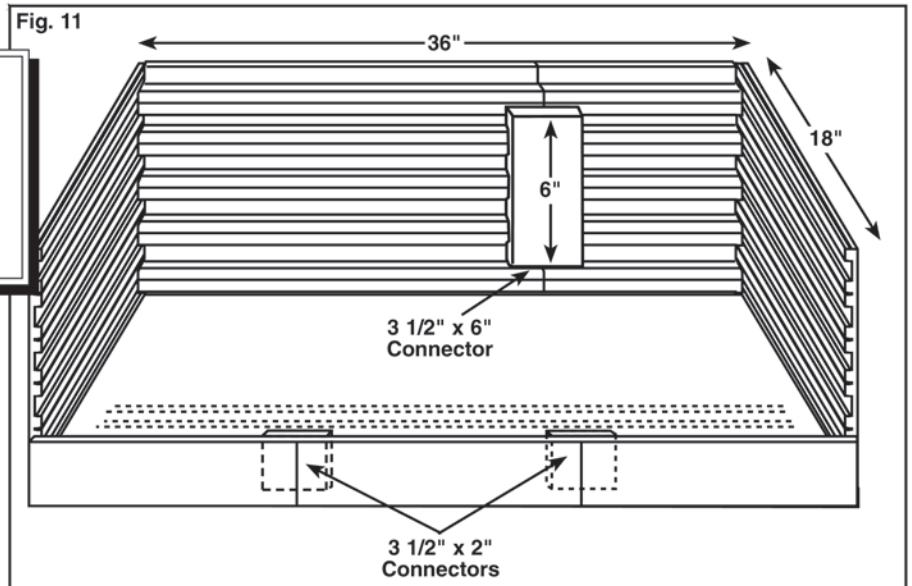
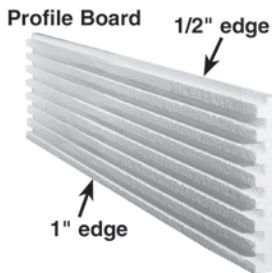

**Fig. 12**

Mark the four Profile Boards as shown for the Straight Module.

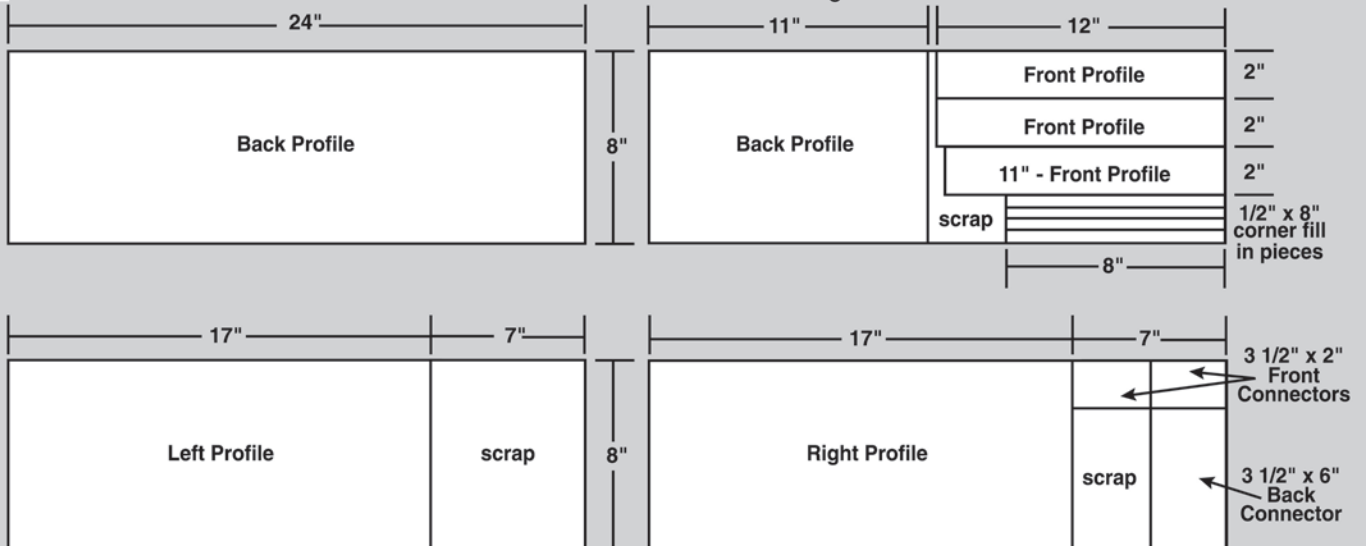



## Install Profile Boards

Start at the back corner of the module and glue the Profile Boards in place. The back and front Profile Boards are assembled with the 1" edge down (ribs inward). The left and right Profile Boards will be assembled with the 1/2" edge down (ribs inward, Fig. 13).

Use the 3 1/2" x 6" Profile Board Connector for the back (Fig. 14). Connectors interlock Profile Boards at the seams in a tongue and groove fashion. Use the 3 1/2" x 2" Connectors in the front to connect the three Profile Boards (Fig. 15).

**IMPORTANT:** Use a square to make sure the Profile Boards are perpendicular to the base, so that they match adjoining modules before gluing (Fig. 16).

### Items Needed

- Profile Boards
- Foam Knife, Hot Wire Foam Cutter or hobby knife
- Ruler or straightedge
- Square
- Pencil or Foam Pencil
- Cardboard
- Foam Tack Glue or Low Temp Foam Glue Gun and Glue Sticks

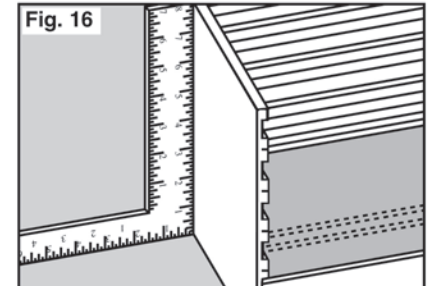
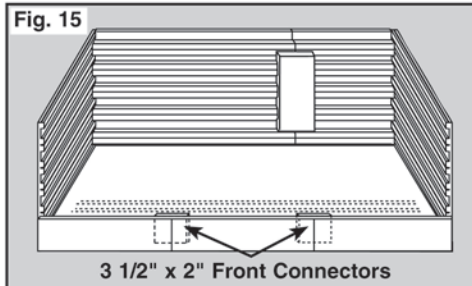
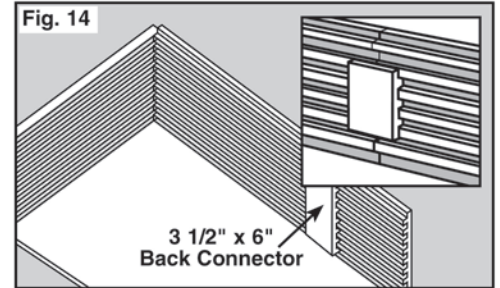
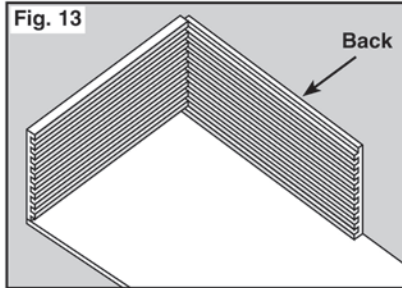

## Attach Connector Plates

Each kit includes two Connector Plates with hardware. Connector Plates are anchors for connecting one module to another with bolts. With these installed, you can easily add another module at any time, even years later. Center the Connector Plates on the 18" sides. Connector Plate holes must match exactly on each module so the bolts can easily be inserted (Fig. 17). Glue the rough side of the Connector Plates to the Profile Board using Foam Tack Glue or Low Temp Foam Glue Gun. Allow to dry.

### Items Needed

- Connector Plates
- Bolts and wing nuts
- Foam Tack Glue or Low Temp Foam Glue Gun and Glue Sticks

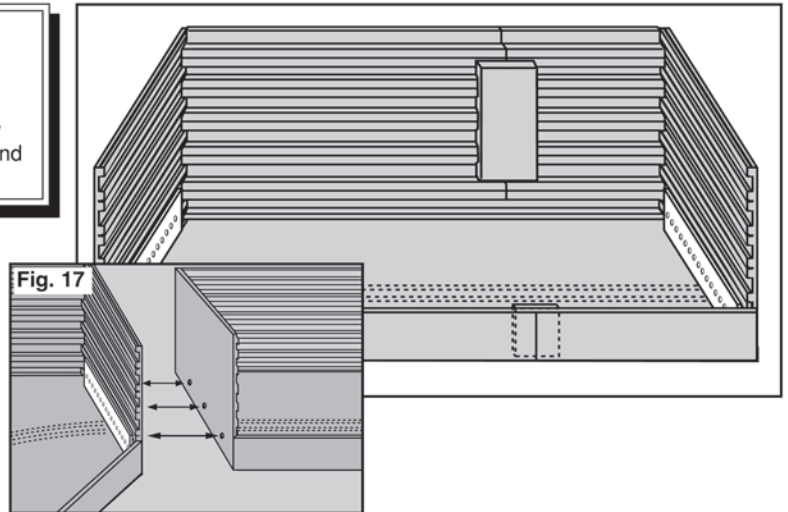
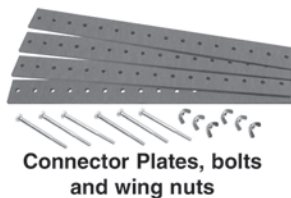

## Install Risers

Risers are flexible foam components that raise the level of your track off the base so you can easily add low-lying areas, such as creeks, streams and drainage ditches beside the tracks.

Center the Risers over the track plan on the base and pin (Fig. 18). Trim any pieces necessary for proper fit. Excess Riser can be used to make roads. Glue Risers into place (Fig. 19).

**NOTE:** N scale parallel tracks can be placed on a single Riser with center-to-center spacing 1 1/2" apart (Fig. 20).

### Items Needed

- Risers
- Foam Knife, Hot Wire Foam Cutter or hobby knife
- Foam Tack Glue or Low Temp Foam Glue Gun and Glue Sticks

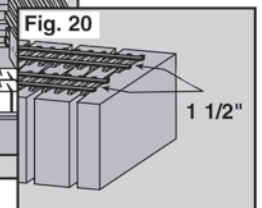
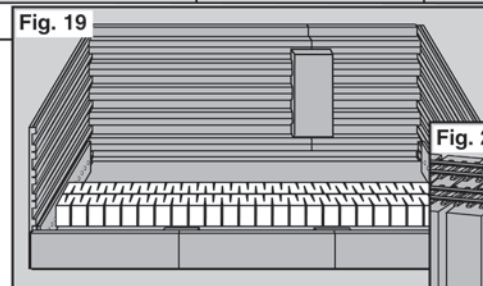
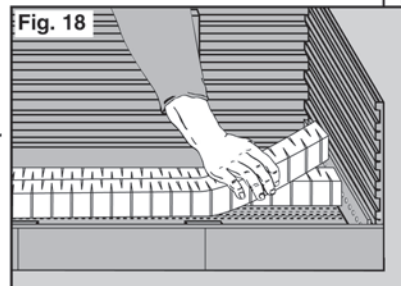
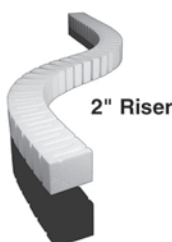



## Cut Contours

Draw the earth contour patterns on the Profile Boards with a Foam Pencil. Use the Hot Wire Foam Cutter, Foam Knife or hobby knife to cut earth contours following your pattern (**Fig. 21**).

You will need to fill the outside corners of the Profile Boards. Use 1/2" x 1/2" x 8" (**Fig. 22**) strips of foam cut from Profile Boards.

Test-fit the strips, then apply glue in the outside corners and insert the strips. When glue is dry, trim if necessary.

**Items Needed**

- Foam Knife, Hot Wire Foam Cutter or hobby knife
- Pencil or Foam Pencil

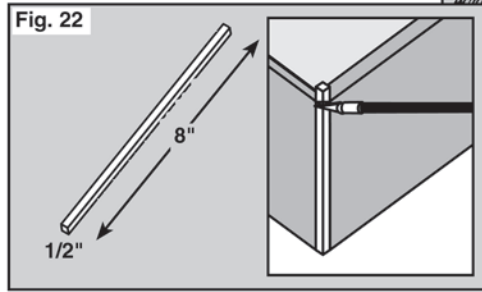
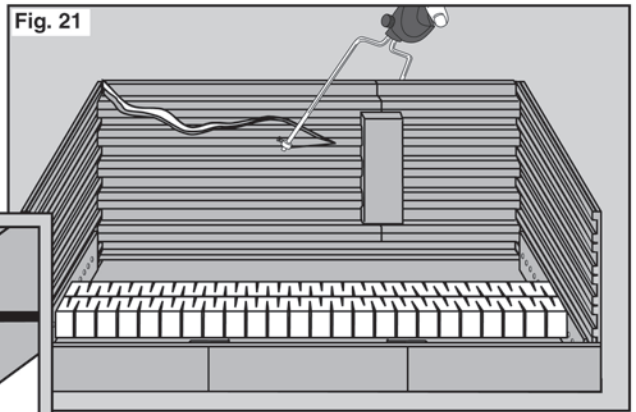

## Open Bolt Holes

After your Connector Plates and Risers are installed, you'll need to open up the holes for the Connector Bolts.

Choose two or three holes for bolt placement. Ideally, the bolts should be located with one on each end and one in the middle of the Connector Plate.

Push a Foam Nail, toothpick or small nail through the chosen Connector Plate holes from the inside (**Fig. 23**), just until the end pokes through the Profile Board on the outside.

Push a bolt straight through one of the holes from the outside,

threading as you push (**Fig. 24**), until the bolt passes through the Connector Plate. This will create a clean hole. Remove the bolt and do the rest of the holes.

**Items Needed**

- Connector Bolts
- Toothpick, small nail or Foam Nails

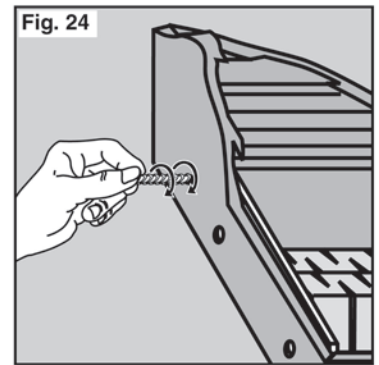
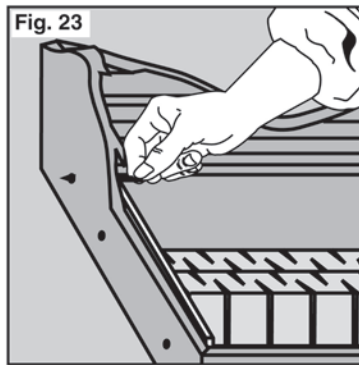

## Cut Access Holes

Access Holes provide access to the Connector Plates, which allow you to connect your module to another.

Cut out your Access Holes keeping them 1 1/2" from either side of the Riser and next to the Profile Boards. Make those holes at least 3" wide (**Fig. 25**).

**Items Needed**

- Foam Knife, Hot Wire Foam Cutter or hobby knife
- Ruler or straightedge
- Pencil or Foam Pencil

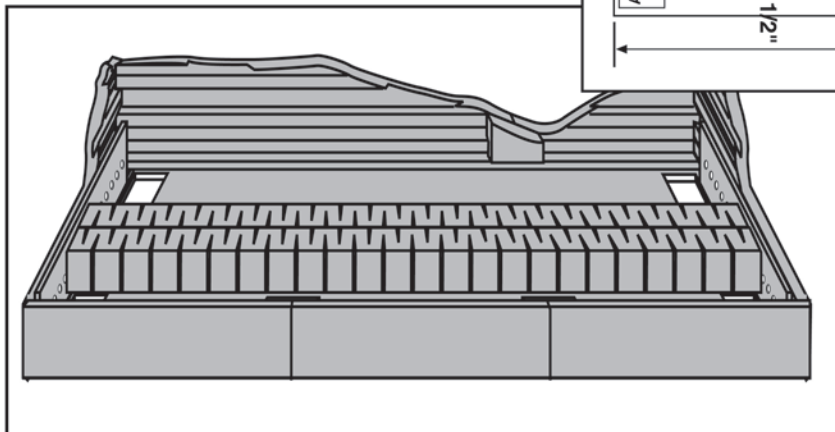
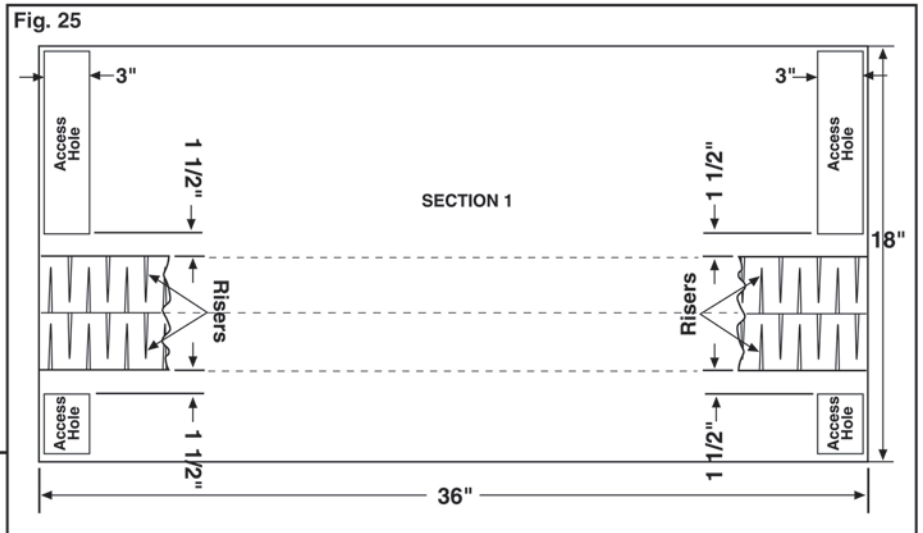



# Create Contours and Apply Plaster Cloth

## Add Paper Wads

You can add dimension and depth to your module by building the contours up with paper wads. You can use No-News Paper or newspaper to create paper wads.

Pillow sheets of paper by wadding them in and under (Fig. 26). Tuck them in the open areas of your layout, following the contours of the Profile Boards and secure with masking tape as you go (Fig. 27).

Leave some areas lower than others for variation in the landscape.

**NOTE:** You may want to install your wiring prior to adding the Plaster Cloth.

### Items Needed

- No-News Paper or newspaper
- Masking Tape

Fig. 26

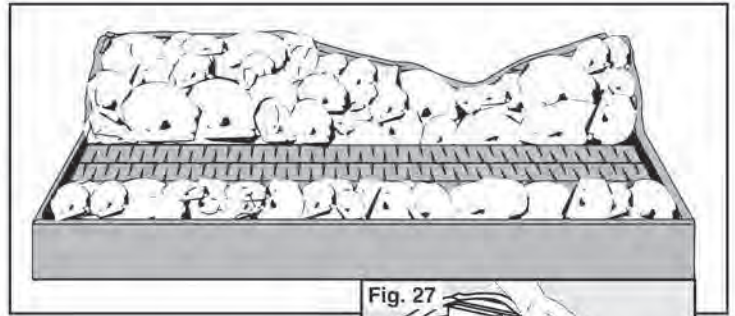

Fig. 27



## Add Plaster Cloth to Risers

Plaster Cloth is plaster-impregnated gauze. The plaster is activated when you add water and smooth the cloth with your fingers or paintbrush. When it dries, it forms a hard shell.

Cut an 18" strip of Plaster Cloth for attaching rocks and a 9' strip for covering the outside and set aside for later. Measure the length of the Risers to determine how long to cut the Plaster Cloth. Add 1/2" to that length and cut.

Center the strip on top of the Risers, bumpy side up, and spray water onto the Plaster Cloth to saturate (Fig. 28).

Smooth with your fingers or paintbrush. This will create a smooth surface to use when it comes time to attach the Track-Bed and track. **TIP:** Only the piece you are working with should come in contact with water, as the plaster becomes stiff and difficult to work with.

**NOTE:** If you are making tunnels on your layout, you will need to add Track-Bed, track and Ballast in this area before proceeding (Fig. 29). We will explain this process in a later section (page 20).

### Items Needed

- Plaster Cloth
- Scissors
- Spray bottle
- 2" paintbrush (optional)
- Ruler or straightedge

Plaster Cloth



Fig. 28

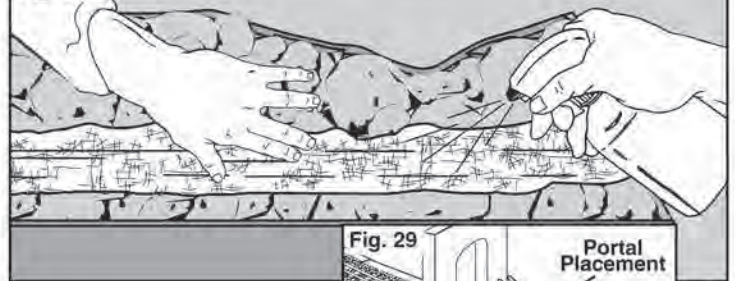
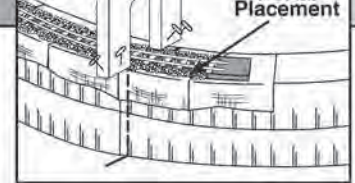

Fig. 29



## Plaster Cloth Layout

**TIP:** When applying Plaster Cloth to the rest of the layout, do not overlap on the Riser.

To cover the layout, start by cutting about 15 pieces of Plaster Cloth 12" long (cut additional pieces as needed). Begin at the front left hand corner, dip a piece of Plaster Cloth into water (Fig. 30) and apply to the surface, overlapping each piece by 50 percent to form a thick plaster surface.

Always apply bumpy side up and smooth with your fingers. At the edges of the module, fold the Plaster Cloth back on itself to keep the sides smooth (Fig. 31).

Continue this until the entire surface is covered. Allow Plaster Cloth to dry thoroughly.

### Items Needed

- Plaster Cloth
- Scissors
- Spray bottle for water (optional)
- Pan for water
- Water

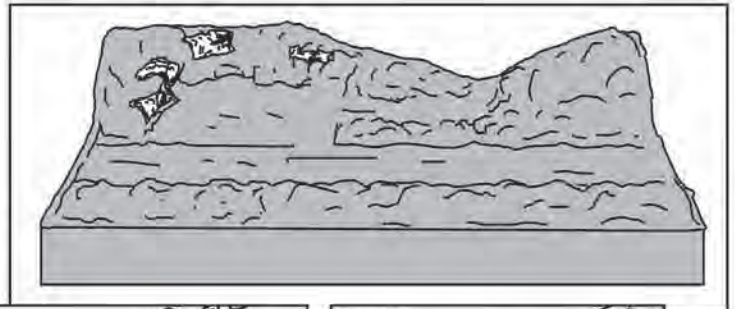

Fig. 30

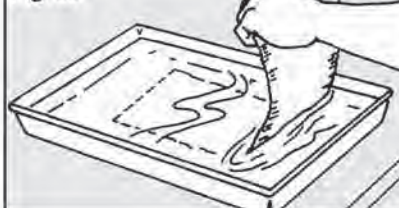
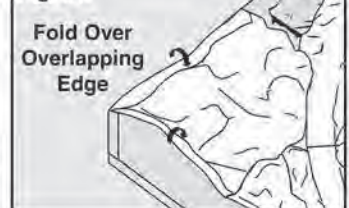

Fig. 31



TURN TO PAGE 16 TO FINISH CONSTRUCTION



# BEGIN BUILDING THE CORNER MODULE KIT (ST4802).

## Corner Module Kit

### Base Preparation

Glue the two Base sections together by running a bead of Low Temp Foam Glue or Foam Tack Glue down the edge of one Base section (Fig. 32). Press sections together. Use Foam Nails to pin sections together while drying. Wipe excess glue from top of Base (this can form a ridge that can affect track installation). Allow to dry. This forms a 36" x 36" piece.

Measure, mark and trim the Base to form two 18" length sides (Fig. 33). These 18" sides will match up with our Mod-U-Rail Straight Module Kit and act as the joining sides for future modules. The 18" sides are where the track will typically enter and exit the module.

Save scrap Base foam for making flat areas on your layout. Refer to page 21 for more instructions on Making Flat, Level Areas.

**NOTE:** If using as a square module, do not cut off the corner (Fig. 33a).

Use a pencil or Foam Pencil to trace your track plan on the Base.

- Items Needed**
- Base
  - Foam Tack Glue or Low Temp Foam Glue Gun and Glue Sticks
  - Foam Knife, Hot Wire Foam Cutter, or hobby knife
  - Foam Nails
  - Ruler or straightedge
  - Pencil or Foam Pencil

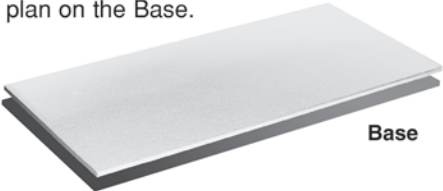
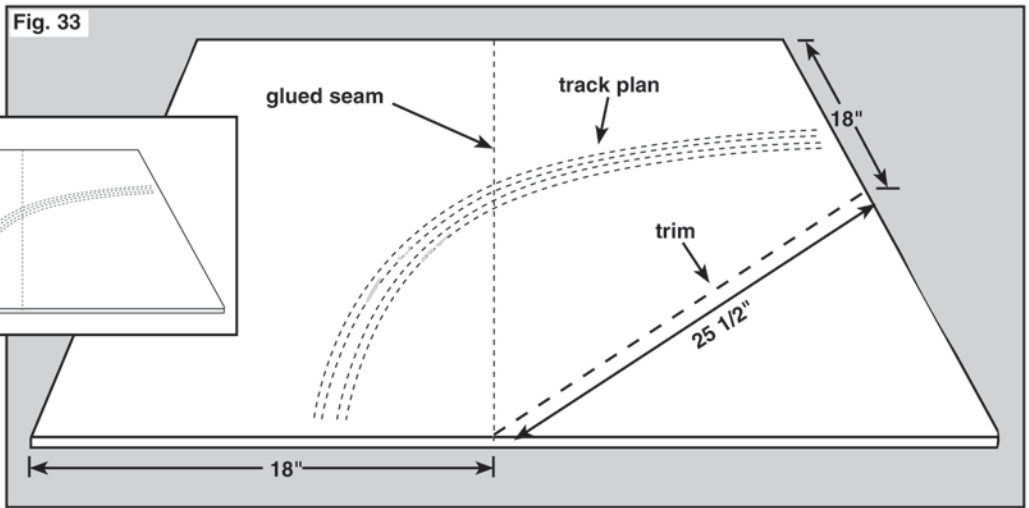
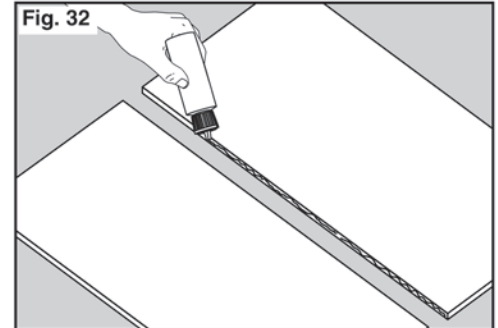

### Test-Fit Track

Assemble and pin your track on the Base according to the track plan you've designed (Fig. 34).

**NOTE:** You can make a loop only in N, S or Z scale on one Corner Module Kit, but you can make a loop with more modules in other scales.

Remember the "Track Placement From Edge" rule (page 6, Fig. 35). Keep this in mind while designing your layout and track.

At this point, you will need to decide if you want rivers, streams or other water areas. You will need to plan for them, and for the installation of tunnels or bridges. After you have placed your track, make markings on the base where you would like any of these features (Fig. 36). Remove the pins and the track and set aside.

- Items Needed**
- Track
  - Base
  - Foam Nails
  - Ruler or straightedge
  - Pencil or Foam Pencil

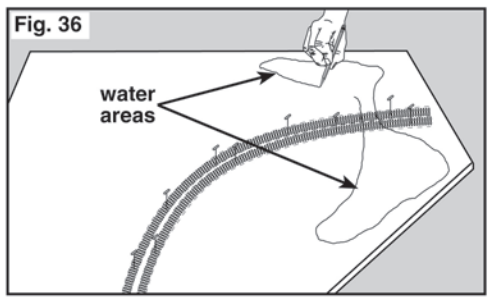
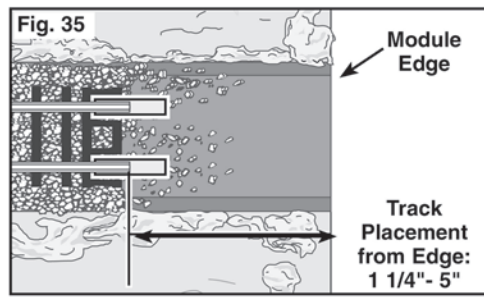
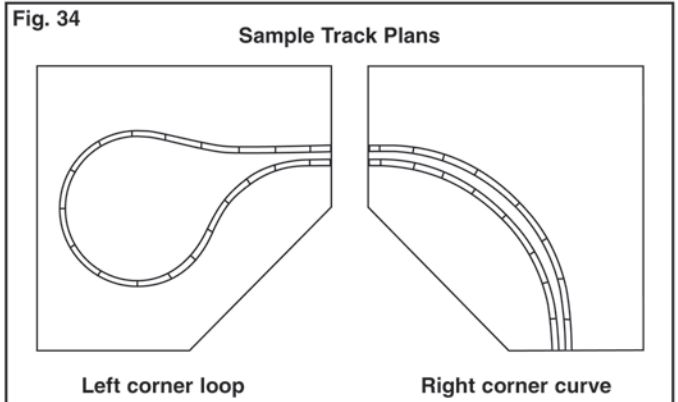

## Mark and Cut Profile Boards

Profile Boards are ribbed, 8" x 24" interlocking components with a 1/2" thickness on one edge and a 1" thickness on the other. They provide the perimeter of your module.

This module kit contains enough materials for an 8" contour height on the back side (Fig. 37). Mark the six Profile Boards with a pencil or Foam Pencil (Fig. 38). Cut using Woodland Scenics Hot Wire Foam Cutter, Foam Knife or hobby knife.

**NOTE:** If making a square module, adjust accordingly.

**Items Needed**

- Profile Boards
- Foam Knife, Hot Wire Foam Cutter or hobby knife
- Ruler or straightedge
- Pencil or Foam Pencil

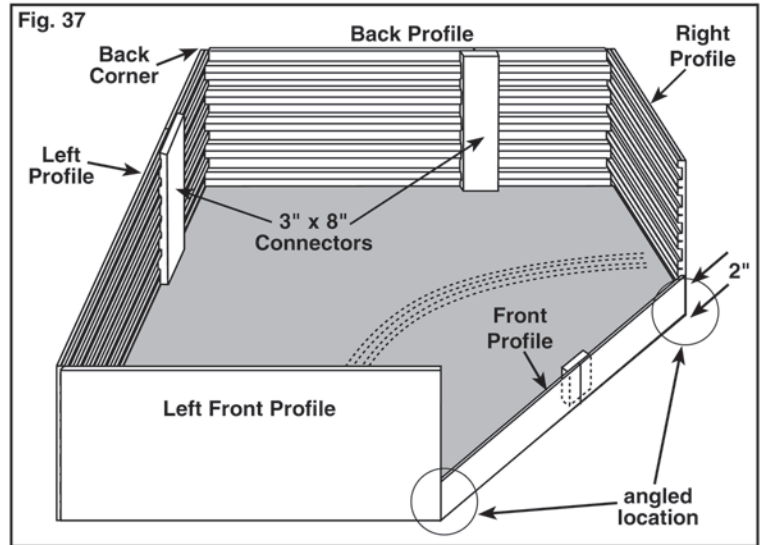
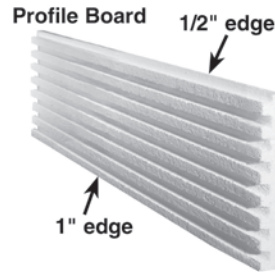
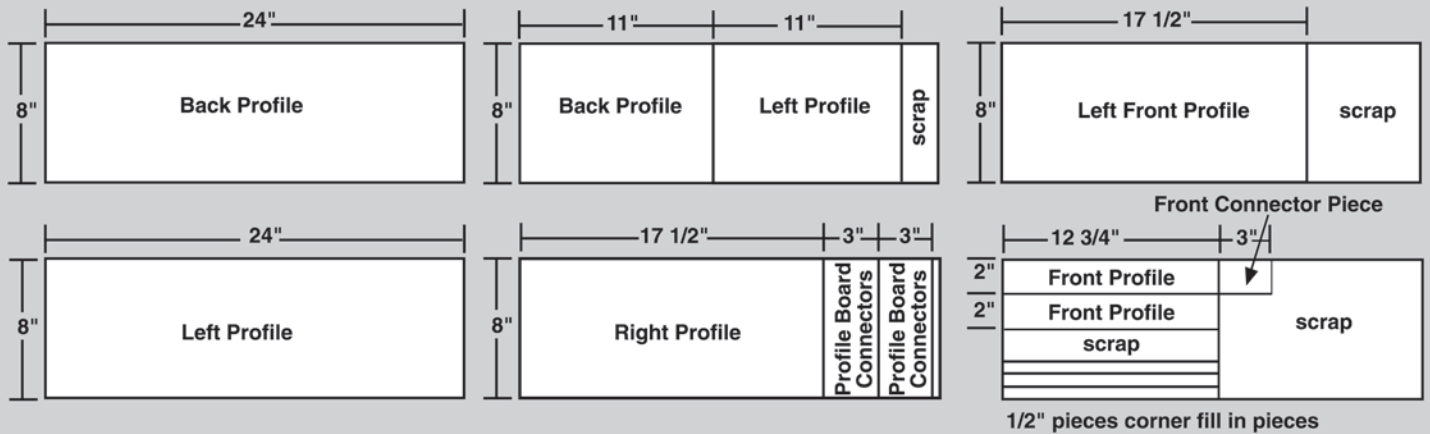

Fig. 38

Mark the six Profile Boards as shown for the Corner Module.



## Install Profile Boards

The back, left front and front Profile Boards are assembled with the 1" edge down (ribs inward). The left and right Profile Boards will be assembled with the 1/2" edge down (ribs inward, Fig. 39) so that corners will interlock.

Use the 3" x 8" Profile Board Connectors for the back and left side of the Profile Boards. Connectors interlock Profile Boards at the seams in a tongue and groove fashion (Fig. 40).

Start at the back corner of the module and glue the Profile Boards to the Base making sure that the corners are interlocked.

Use the 3" x 2" Connector to attach the two 12 3/4" front Profile Boards together and glue. Angle-cut both ends (Fig. 41).

To do this, cut a template from cardboard or card stock 2" high and 2" wide, the height of your Profile Board. Score the cardboard down the center 1" (Fig. 42).

Bend the cardboard to a 90° angle and tape the cardboard to the end of the Profile Board (Fig. 43). Cut the angle with a Hot Wire Foam Cutter, Foam Knife or hobby knife at a 45° angle using the cardboard template as a guide (Fig. 44).

**Items Needed**

- Profile Boards
- Foam Knife, Hot Wire Foam Cutter or hobby knife
- Ruler or straightedge
- Pencil or Foam Pencil
- Cardboard
- Foam Tack Glue or Low Temp Foam Glue Gun and Glue Sticks

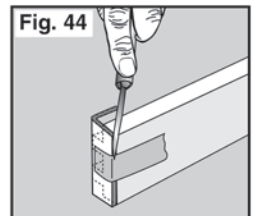
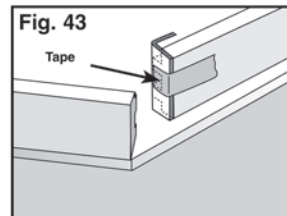
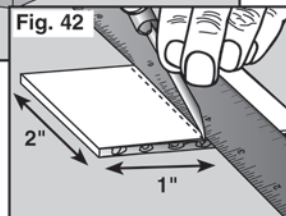
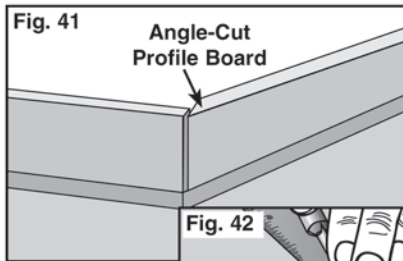
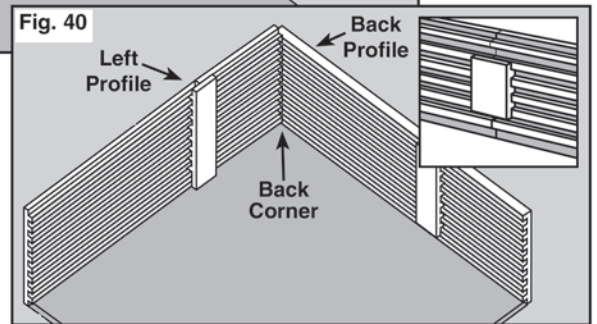
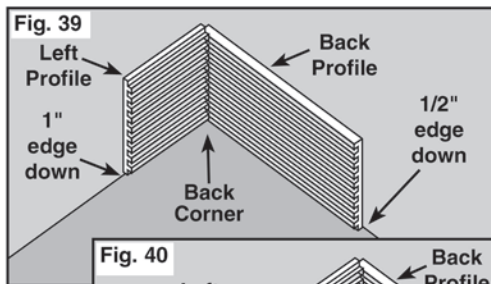



Lay the connected front Profile Boards across the front and glue in place (**Fig. 45**).

**NOTE:** Be careful not to cut front Profile Board too short.

**IMPORTANT:** Use a square to make sure the Profile Boards are perpendicular to base, so that they match adjoining modules before gluing (**Fig. 46**).

Spread glue on the ribs of the 3" x 8" Profile Board Connector and glue into place between the Profile Boards (**Fig. 47**).

Save scrap Profile Boards for flat areas on your layout. Refer to page 21 for more instructions on Making Flat, Level Areas.

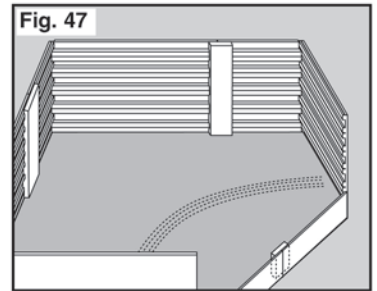
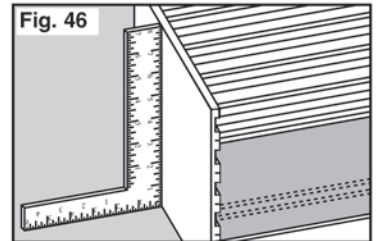
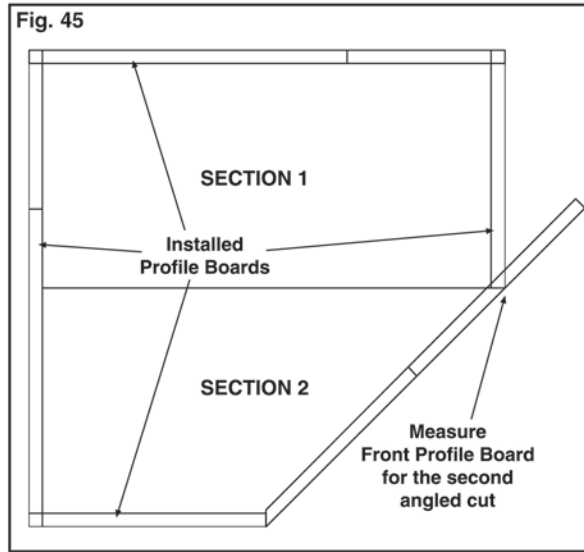

### Attach Connector Plates

Each kit includes two Connector Plates with hardware.

Connector Plates are anchors for connecting one module to another with bolts. With these installed, you can easily add another module at any time, even years later. Center the Connector Plates on the 18" sides. Connector Plate holes must match exactly on each module so the bolts can easily be inserted (**Fig. 48**).

Glue Connector Plates in place. Allow to dry. There will be a gap between the Connector Plate and Profile Board. Fill this gap with excess foam, as you did the outside corner of the module (**Fig. 49**). Make sure the fill piece is level with the Profile Board.

**Items Needed**

- Connector Plates
- Foam Tack Glue or Low Temp Foam Glue Gun and Glue Sticks

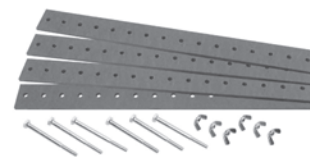
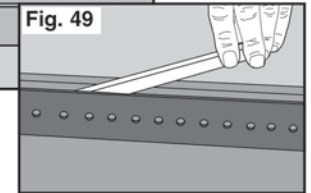
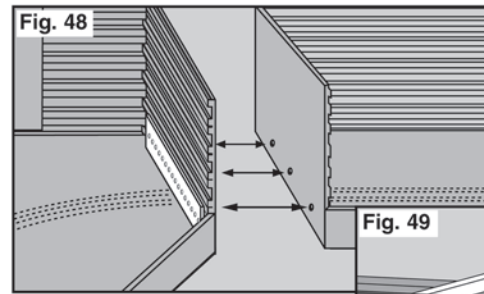

Connector Plates, bolts and wing nuts

### Install Risers

Risers are flexible foam components that raise the level of your track off the Base so you can easily add low-lying areas, such as creeks, streams and drainage ditches beside the tracks. Center the Risers over the track plan on the base and pin. Trim any pieces necessary for proper fit (**Fig. 50**). Glue Risers into place.

**NOTE:** N scale parallel tracks can be placed on a single Riser with center-to-center spacing 1 1/2" apart (**Fig. 51**).

**Items Needed**

- Risers
- Foam Nails
- Foam Knife
- Foam Tack Glue or Low Temp Foam Glue Gun and Glue Sticks

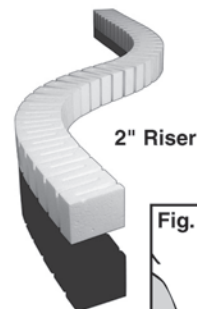
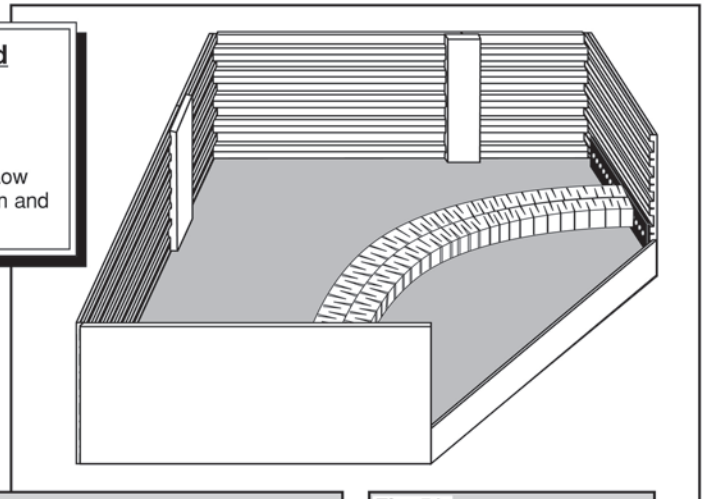

2" Riser

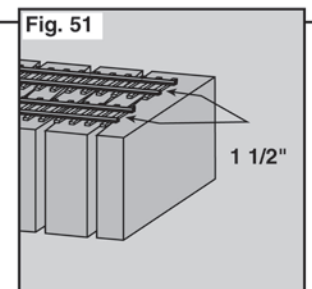
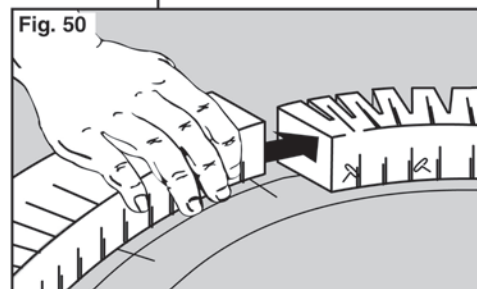

## Cut Contours

Draw the earth contour patterns on the Profile Boards with a Foam Pencil. Use the Hot Wire Foam Cutter, Foam Knife or hobby knife to cut earth contours following your pattern (Fig. 52).

You will need to fill the outside corners of the Profile Boards. Use 1/2" x 1/2" x 8" (Fig. 53) strips of foam cut from Profile Boards. Test-fit the strips, apply glue in the outside corners, insert the strips and trim, if necessary, when the glue is dry.

**Items Needed**

- Foam Knife, Hot Wire Foam Cutter or hobby knife
- Pencil or Foam Pencil

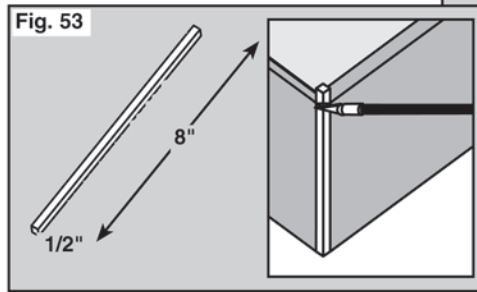
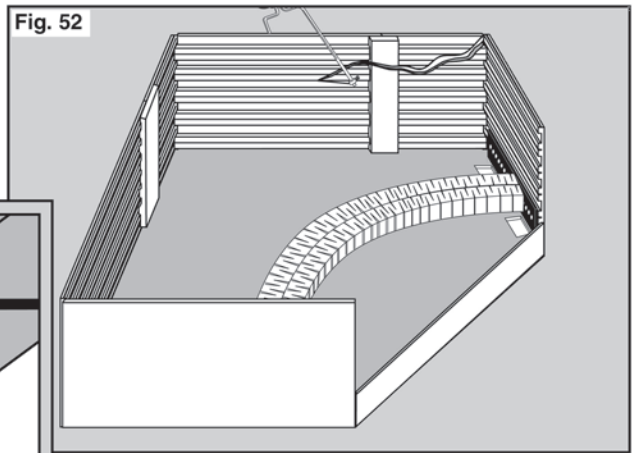

## Open Bolt Holes

After your Connector Plates and Risers are installed, you'll need to open up the holes for the Connector Bolts.

Choose two or three holes for bolt placement. Ideally, the bolts should be located with one on each end and one in the middle.

Push a Foam Nail, toothpick or small nail through the chosen Connector Plate holes from the inside (Fig. 54), just until the end pokes through the Profile Board on the outside.

Push a bolt straight through one of the holes from the outside, threading as you push (Fig. 55), until the bolt passes through the Connector Plate. This will create a clean hole. Remove the bolt and do the rest of the holes.

**Items Needed**

- Connector Bolts
- Toothpick, Foam Nail or small nail

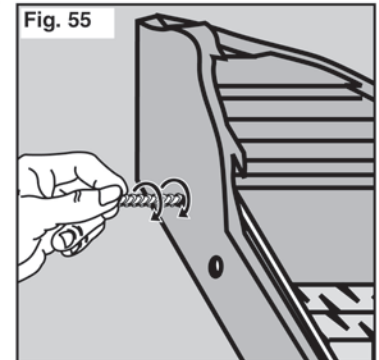
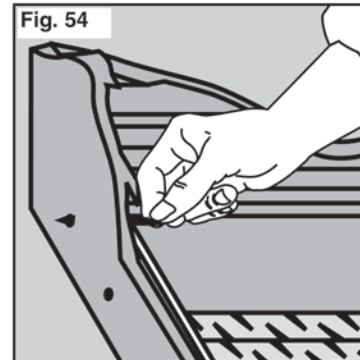

## Cut Access Holes

Access Holes provide access to the Connector Plates, which allow you to easily and cleanly connect your module to another.

Cut out your Access Holes keeping them 1 1/2" from either side of the Riser and next to the Profile Board (Fig. 56). Make those holes at least 3" wide.

**Items Needed**

- Foam Knife, Hot Wire Foam Cutter or hobby knife
- Ruler or straightedge
- Pencil or Foam Pencil

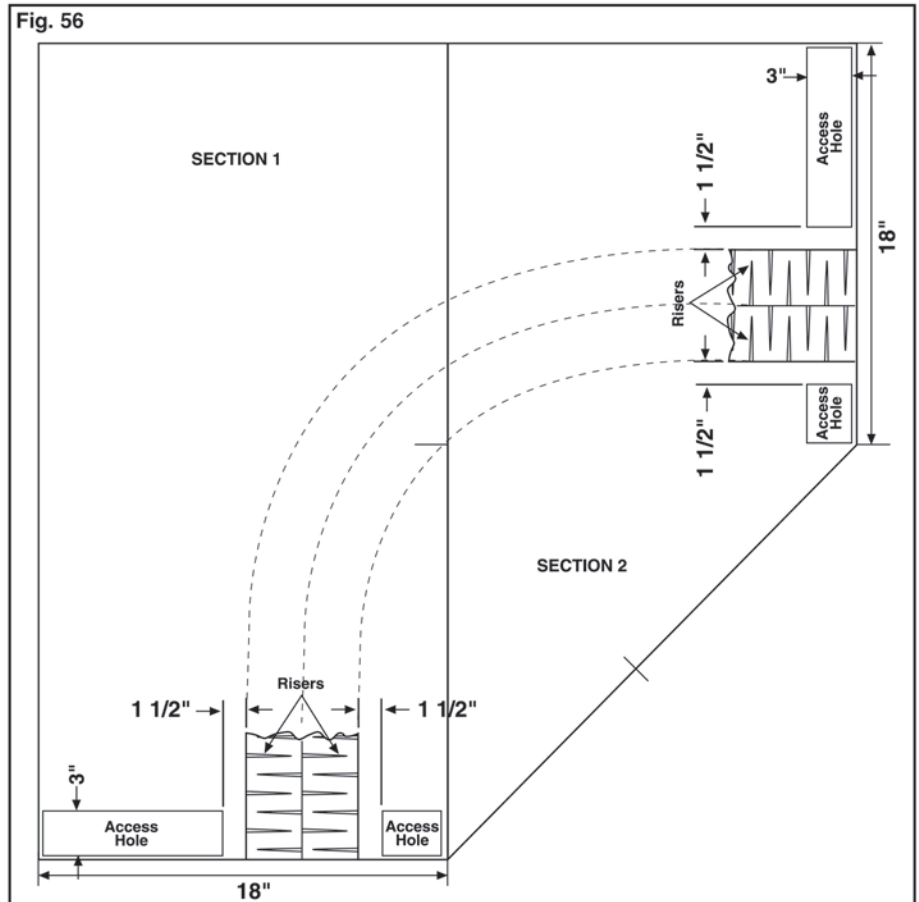
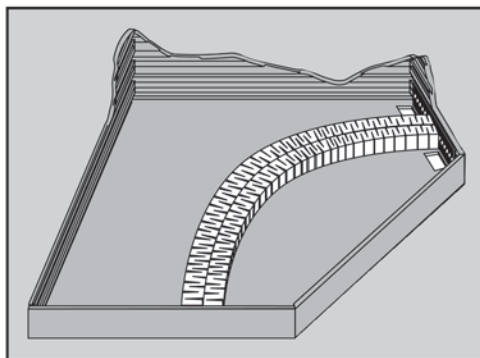



# Create Contours and Apply Plaster Cloth

## Add Paper Wads

You can add dimension and depth to your module by building the contours up with paper wads. You can use No-News Paper or newspaper to create paper wads.

Pillow sheets of paper by wadding them in and under (Fig. 57). Tuck them in the open areas of your layout, following the contours of the Profile Boards and secure with masking tape as you go (Fig. 58).

Leave some areas lower than others for variation in the landscape.

**NOTE:** You may want to install your wiring prior to adding the Plaster Cloth.

- Items Needed**
- No-News Paper or newspaper
  - Masking Tape

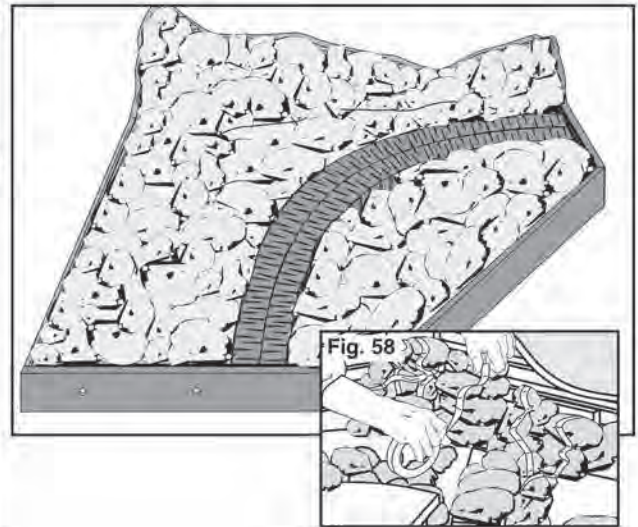

## Add Plaster Cloth to Risers

Plaster Cloth is plaster-impregnated gauze. The plaster is activated when you add water and smooth the cloth with your fingers or paintbrush. When it dries, it forms a hard shell.

Save an 18" strip of Plaster Cloth for attaching rocks and a 11' strip for covering the outside later. Measure the length of the Risers to determine how long to cut the Plaster Cloth. It may be necessary to cut the Plaster Cloth into smaller pieces so that it will lay flat around curves. Add 1/2" to that length and cut. Center the strip on the Riser, bumpy side up, and spray or sponge water onto the Plaster Cloth to saturate (Fig. 59). Smooth with your fingers or paintbrush.

**TIP:** Only the piece you are working with should come in contact with water, as the plaster becomes stiff and difficult to work with.

**NOTE:** If you are making tunnels on your layout, you will need to add Track-Bed, track and Ballast in this area before proceeding. We will explain this process in a later section.

- Items Needed**
- Plaster Cloth
  - Scissors
  - Spray bottle for water (optional)
  - 2" paintbrush (optional)
  - Ruler or straightedge



## Plaster Cloth Layout

**TIP:** When applying Plaster Cloth to the rest of the layout, do not overlap on the Riser.

To cover the layout, start by cutting about 15 pieces of Plaster Cloth 12" long (cut additional pieces as needed). Begin at the front left hand corner, dip a piece of Plaster Cloth into water (Fig. 60) and apply to the surface, overlapping each piece by 50 percent to form a thick plaster surface. Always apply bumpy side up and smooth with your fingers. At the edges of the module, fold the Plaster Cloth back on itself to keep the sides smooth (Fig. 61). Continue this until the entire surface is covered. Allow Plaster Cloth to dry thoroughly.

- Items Needed**
- Plaster Cloth
  - Scissors
  - Spray bottle for water (optional)
  - Pan for water
  - Water

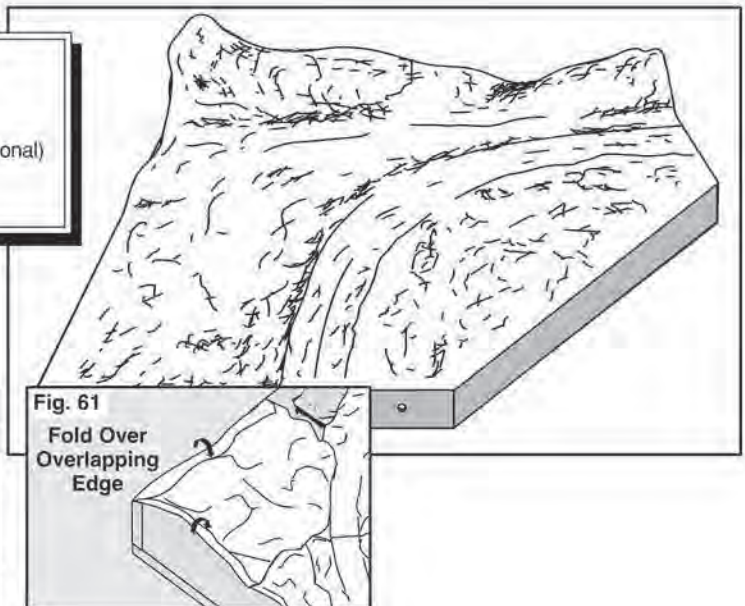
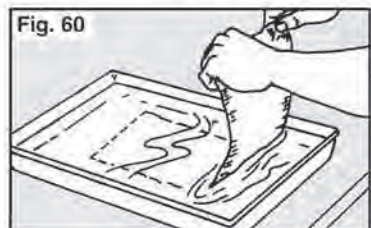



**USE THE FOLLOWING INSTRUCTIONS TO FINISH EITHER THE STRAIGHT MODULE OR CORNER MODULE KIT.**

## Track-Bed, Track, Wiring and Plaster Cloth Sides

### Install Track-Bed

N and HO scale Track-Bed is included, but you may be modeling in another scale. Install your Track-Bed now, no matter the scale.

Track-Bed is a roadbed product that provides a quiet, smooth train operation and absorbs irregularities on your module.

It is time to test-fit the track and redraw the track plan on the Plaster Cloth covered Riser.

Run a bead of Foam Tack Glue down the center of the traced track area and spread it on (Fig. 62). Center the Track-Bed over the traced track area and press into place, pinning as you go (Fig. 63). Allow this to dry and remove Foam Nails.

If you have added tunnels, start from your tunnels and install outward. It is now time to add your track and wiring.

#### Items Needed

- Track-Bed
- Foam Tack Glue
- Scrap Foam
- Foam Knife or hobby knife
- Foam Nails
- Pencil or Foam Pencil

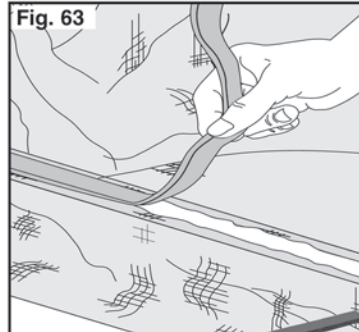
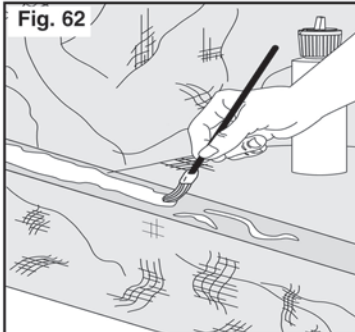

Track-Bed



### Install Track and Wiring

Assemble your track in the correct position on the Track-Bed. Make any adjustments necessary. Remember to keep the track set back from the sides and aligned properly (Fig. 64). Install any wiring at this point.

Starting at one end of the track, remove track sections one at a time. Apply Foam Tack Glue to the surface of the Track-Bed and smooth with a piece of scrap foam. Place the track, pinning as you go (Fig. 65). Double check the track placement. Allow the glue to dry, then remove Foam Nails.

#### Items Needed

- Pencil
- Connector Track
- Masking Tape
- Track pieces
- Foam Tack Glue
- Scrap foam
- Wiring

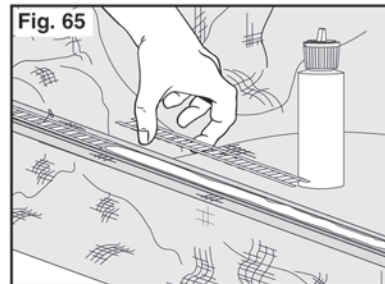
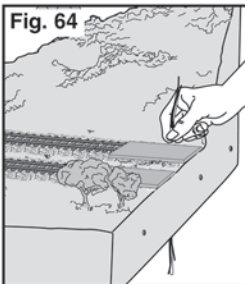

### Plaster Cloth Sides

When you add Plaster Cloth to the sides of your module, it provides a smooth, finished look.

To make this process easier, elevate the module on pieces of scrap Profile Board. Pin a continuous strip of Plaster Cloth to the sides of the module, bumpy side out, with about 3/4" extending below the base edge (Fig. 66). Make sure that Plaster Cloth does not overlap.

Trim the Plaster Cloth to about 3/4" above the side profiles (Fig. 67), except where the track will enter and exit the module. Trim the Plaster Cloth level with these areas.

Cut additional small strips of Plaster Cloth for areas where the Plaster Cloth doesn't extend above the Profile Boards and pin in place.

Make relief cuts at the corners and any dips on the contours of the profile (Fig. 68).

Spray the Plaster Cloth thoroughly with water one side at a time, working the plaster with your fingers to smooth.

**TIP:** Keep a bowl of water handy to rinse your hands off occasionally as you go. This helps keep the Plaster Cloth free of any dried pieces of plaster that accumulates on your hands, and helps make for a smooth finish.

Before the Plaster Cloth is dry, push a pencil through the Plaster Cloth and into the Connector Plate holes, twisting the pencil as you go (Fig. 69).

#### Items Needed

- Scissors
- Plaster Cloth
- Spray bottle for water (optional)
- Pan for water
- Water
- Foam Nails
- Pencil

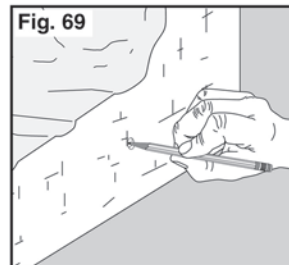
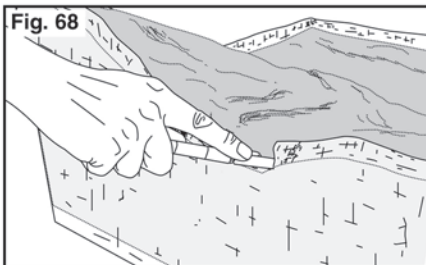
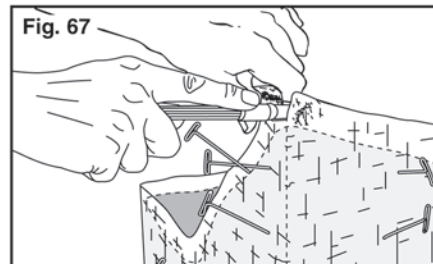
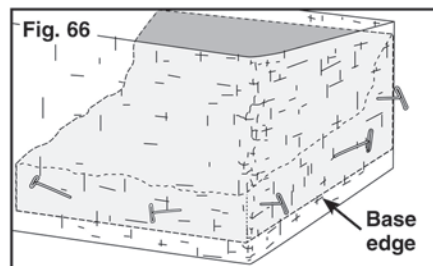



## Install Rocks

Our Rock Castings are made of Lightweight Hydrocal<sup>®</sup> (C1201) and can be shaped, cut, or broken to any size or shape you wish. We use Earth Colors Liquid Pigments to color them.

**TIP:** If you want to add more rocks to your layout, there are several options. For rocks that are hand painted and ready to place on your layout, try Ready Rocks™ (C1136-C1142). To make your own rock castings, try Rock Molds (C1230-C1248).

Cut strips from the Plaster Cloth you saved earlier into 1/4" - 1/2" wide pieces. Test-fit rocks on the module where you want them to go. Push in or cut the Plaster Cloth so rocks will fit (**Fig. 70**). You can cut an "H" shape in the Plaster Cloth for an easy fit. Soak the rock in water for about 30 seconds then take it out and set it on the module. Dip the strips of Plaster Cloth in water. You can use pieces of damp paper towels to fill large gaps if necessary, prior to placing Plaster Cloth strips. Lay the strips around the rock and smooth the strips to blend into the module, filling the gaps (**Fig. 71**).

\*Hydrocal is a US. Gypsum registered trademark.

### Items Needed

- Plaster Cloth strips
- Scissors
- Foam Knife or hobby knife
- Rock Castings
- Bowl of water
- Paper Towels (optional)

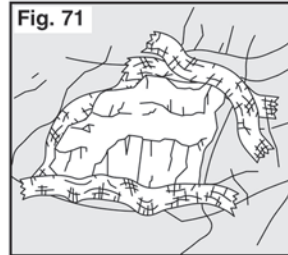
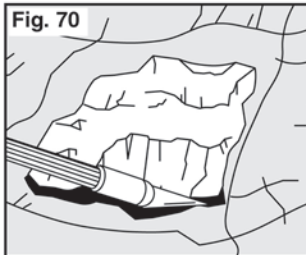

## Color Rocks

Earth Colors Liquid Pigment is perfect for coloring rock outcroppings. Our "Leopard Spot" method is very easy and helps you obtain the most realistic-looking rocks.

In separate containers, mix Burnt Umber and Yellow Ocher with 1 tsp of water, and mix Black with 2 tsp of water. Do not mix pigments together. Use the Foam Pad Applicator and randomly dab Burnt Umber over 1/3 of the rock. Rinse the pad and dab Yellow Ocher on 1/3 of the rock, then rinse the pad again and apply Black Wash to the entire rock to bring out the detail and tie the colors together. You may apply as many coats of Black Wash as you wish (**Fig. 72**).

### Items Needed

- Three disposable cups
- Earth Colors Liquid Pigment
- Teaspoon
- Water
- Foam Pad Applicator

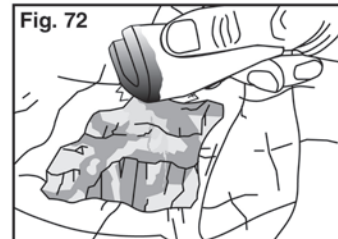

## Apply Earth Undercoat

Earth Undercoat covers the white Plaster Cloth and collects in the folds of the terrain, creating a splotchy surface that provides a realistic appearance when covered with landscaping products.

Mix the Earth Undercoat with 10 oz water. Use Foam Pad Applicator or 2" paintbrush to cover the Plaster Cloth, avoiding the rock faces (**Fig. 73**).

Save left over Earth Undercoat for painting adjoining sides.

## Ballast Track

Ballast on a real railroad stabilizes the ties and rails. It is usually made from local gravel. Our Ballast should be applied so that the Ballast is even, with the top of the ties exposed.

Cover the top of the ends of the Track-Bed with masking tape as shown before ballasting (**Fig. 74**). This area must be clean to place the Connector Track Pieces later.

Brush the beveled sides of the Track-Bed with Scenic Cement (**Fig. 75**). Carefully pour Ballast down the middle of the track (**Fig. 76**). Make sure no Track-Bed shows through.

Brush off excess Ballast from the ties and rails and spread evenly with a small paintbrush (**Fig. 77**). Spray "wet water" (2 drops of liquid soap to 6 oz of water) on Ballast to pre-saturate so Scenic Cement absorbs without the Ballast clumping.

Use an eyedropper or drinking straw (or Sprayhead) to saturate the Ballast with Scenic Cement (**Fig. 78**). When dry, carefully remove the tape from the ends of the track.

**TIP:** You can create the illusion of ballasted track in the Connector Track area by using the following steps. Turn the Connector Track piece to its back side and apply masking tape. Turn the track upright and pour on Ballast. Gently brush the Ballast even with ties. Then spray with Scenic Cement to hold the Ballast secure. Dry thoroughly and clean off the track.

- ### Items Needed
- Earth Undercoat
  - Disposable cup
  - Measuring cup
  - Foam Pad Applicator or paintbrush
  - Water

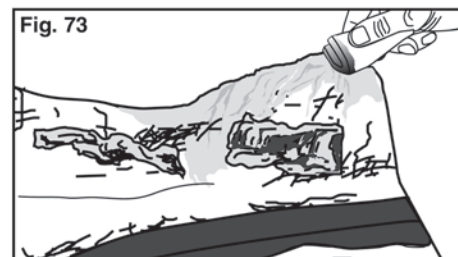

### Items Needed

- Ballast
- Eyedropper or drinking straw
- Scenic Cement
- Scenic Cement Spray Head (optional)
- Masking Tape
- Small paintbrush for wet application
- Small dry paintbrush for brushing ballast

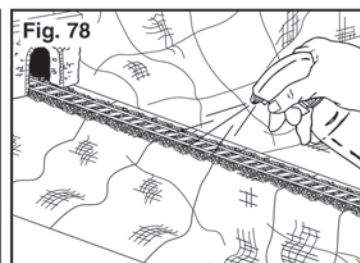
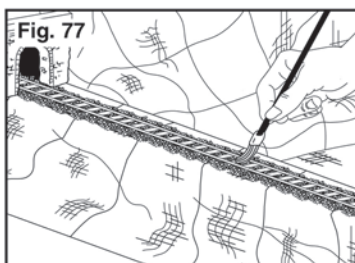
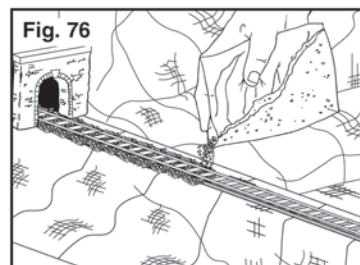
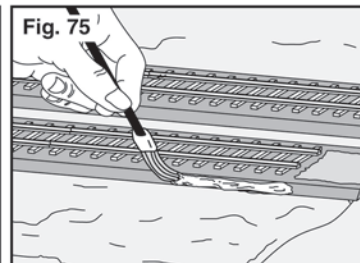
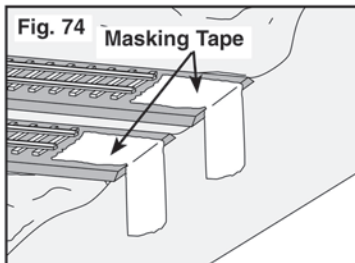

## Make Trees

Trees add realism to any module or layout. No two trees that you make will ever look alike, because you shape them individually. You can add or remove foliage for a different look.

Remove the bases from the Tree Armatures.

Twist and bend the Armatures into a realistic three-dimensional shape (**Fig. 79**). Brush Hob-e-Tac Adhesive on the branches of the Armature and allow to dry until adhesive becomes clear and tacky (**Fig. 80**). Dip Armatures in Clump-Foliage (**Fig. 81**) and pick off excess. Save the remaining foliage for landscaping.

**NOTE:** You may need to tear Clump-Foliage into smaller pieces before applying to Tree Armatures.

### Items Needed

- Tree Armatures
- Hob-e-Tac Adhesive
- Clump-Foliage

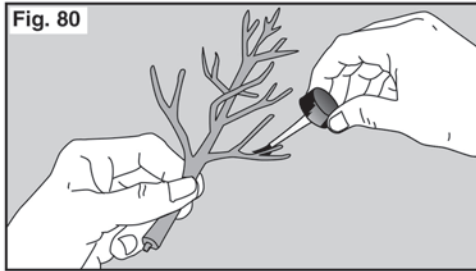

## Apply Low Ground Cover

Low ground covers are low grasses, small plants, shrubs and bushes, rocks, gravel and weeds. These provide a natural base upon which you will landscape your module. Make sure the Ballast has thoroughly dried, and cover all track with 1" wide masking tape before beginning.

Cut a corner from the Green Blend Blended Turf, fill the Sifter Cup, and attach Lid. Set Scenic Cement sprayer to "mist" and spray a one-square-foot area of the module (**Fig. 82**), avoiding rock faces. Lightly sprinkle on Green Blend. Continue until the entire module is covered. Leave patches of Earth Undercoat visible for a realistic appearance.

Sprinkle the following Fine Turf sparingly:

- Soil Fine Turf: in ditches, creek bottoms, along edge of Ballast, in natural dips in landscape.
- Earth Fine Turf: for vertical areas, exposed earth, creeks and ditch edges, and randomly on Green Blend to add color variation.
- Yellow Grass Fine Turf: highlighter for high spots, creating dried or dead grass, or to add color variation.

Spray all turfed areas with Scenic Cement.

### Items Needed

- Green Blend Blended Turf
- Soil Fine Turf
- Earth Fine Turf
- Yellow Grass Fine Turf
- Brown Talus
- Sifter Cup and Lid
- Scenic Cement
- Scenic Cement Spray Head
- Masking Tape

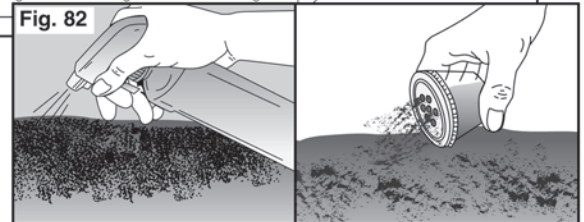
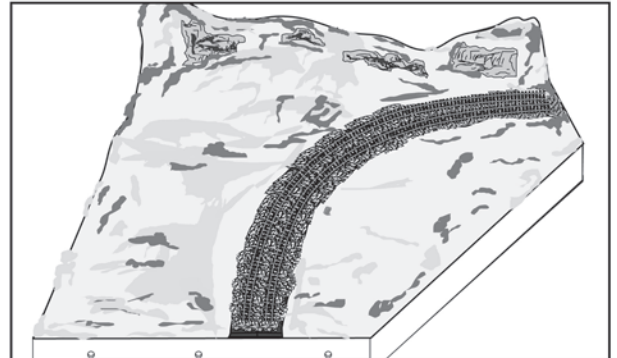

## Apply Medium Ground Cover

Coarse Turf provides a smooth transition between low ground covers and larger bushes and shrubs.

Sprinkle Coarse Turf along the edges of the Ballast to simulate weeds and to soften the texture (**Fig. 83**).

Sprinkle randomly around the entire module. Use the remaining Clump-Foliage to represent bushes and low-growing brush. It looks best when placed in random clusters. Attach with Scenic Glue. Sprinkle with Yellow Grass Fine Turf to highlight.

Use Talus (brown) in low-lying areas, at the base of rock outcroppings and hills and in natural dips in the landscape. Attach with 50/50 mix of Scenic Glue and water (**Fig. 84**). Add a small amount of Soil and Earth Fine Turf if desired. Overspray with Scenic Cement and allow to dry thoroughly.

### Items Needed

- Coarse Turf
- Scenic Cement
- Scenic Cement Spray Head
- Scenic Glue
- Water

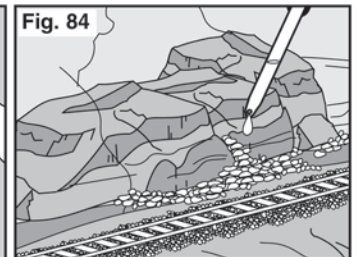
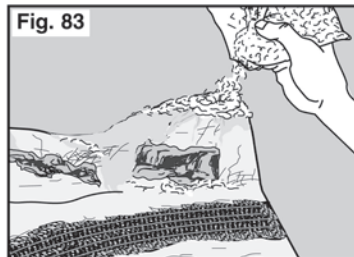



## Attach Trees

Use the trees you made earlier to create natural landscaping. Trees look most natural in groups of three or five, and in varying shades within these groups.

Spray the trees with Scenic Cement (Fig. 85). Sprinkle with Earth and Yellow Grass Fine Turf to add highlights and depth (Fig. 86).

Poke a hole in the Plaster Cloth. Apply a drop of Scenic Glue to the bottom of the tree and plant it in the pinhole (Fig. 87).

Now remove the masking tape from the tracks and your layout is complete. All you need to do is paint the sides of the module.

### Items Needed

- Trees (you made earlier)
- Earth Fine Turf
- Yellow Grass Fine Turf
- Foam Nails
- Scenic Glue
- Scenic Cement
- Scenic Cement Spray Head

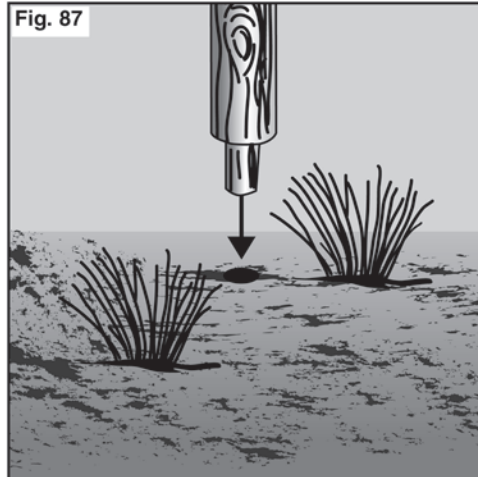
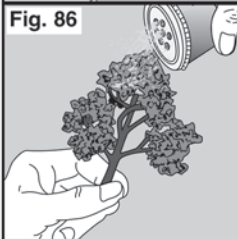
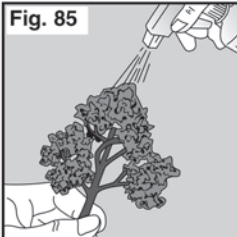

## Finish Module

### Paint Sides of Module

**TIP:** Lightly sand sides to provide a smooth surface.

Painting the sides of the module gives it a finished look (Fig. 88).

Elevate the module with pieces of scrap foam. Use the Base Paint provided to paint the outside of the module.

**OPTIONAL:** You may want to use the Earth Colors Liquid Pigment for painting adjoining sides as the base paint may show when connected.

### Items Needed

- Scrap Profile Board
- Base Paint (included)
- Earth Colors Liquid Pigment
- Small tray roller or paintbrush

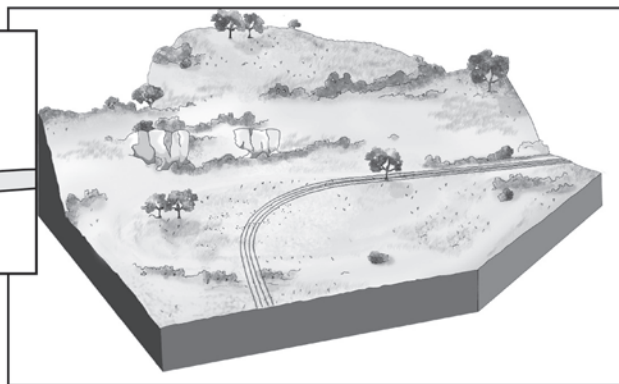
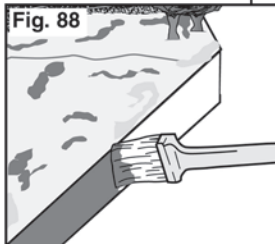

### Connect Modules

Attach a Track Connector piece to the rail ends of the track (Fig. 89). Set modules in order and line up, but do not push together yet.

Reach up under the Connector Access Holes and remove or push aside the newspaper wads to install the three Connector Bolts. Carefully push the Connector Bolts through the holes from the inside of one module and clean away debris (Fig. 90).

Slowly push the adjoining module toward the first, guiding the bolts in as you go.

With the Connector Bolts pushed through the Connector Plate of the adjoining module, reach underneath the module and attach Wing Nuts to each bolt end.

Hold the head of the bolt and turn the Wing Nuts, alternating between the bolts until the **modules are about 1/4" apart**.

Line up the track ends and very carefully push the two modules together (Fig. 91). Make sure the Track Connector Pieces engage correctly. Check the track joints by running your finger across them and adjust if necessary. Tighten the Wing Nuts with your fingers only (do not torque the Wing Nuts too tightly). Make sure the track stays lined up.

**IMPORTANT:** To clean the rails, use the Rail Tracker™ Cleaning Kit (TT4550) or a sanding block with 600-grit sandpaper to remove any Scenic Cement overspray.

### Items Needed

- 3" x 1/4" - 3 Connector Bolts (included in kit)
- Wing Nuts (included in kit)
- Connector Track Pieces
- Track Connectors

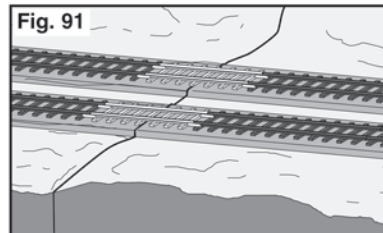
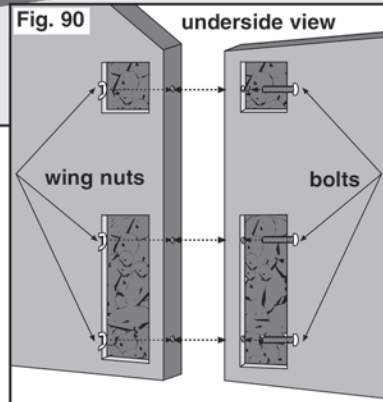
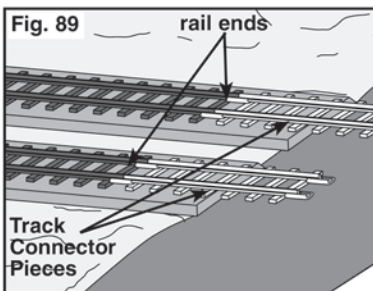
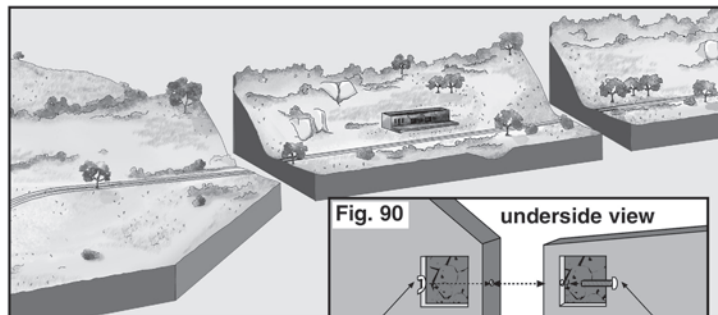

# Add Additional Features

## Add Unique Features to Your Layout

You can individualize your module by adding overpasses, bridges, tunnels with portals, retaining walls and water areas. Though some of these features are not included in this module kit, we have given you instruction for adding them. Check your local hobby shop for availability, or online at [www.woodlandscenics.com](http://www.woodlandscenics.com).

Risers (ST1406-ST1409, ST1414)	N / HO Scale Culverts (C1162-C1165 / C1262-C1265)	Water Effects® (C1212)
Inclines/Declines (ST1410-ST1413, ST1415-ST1416)	Fine Turf (T41-T46, T49-T50, bag)	Deep Pour Water™ (CW4510, CW4511)
Profile Boards (ST1419)	Fine Turf (T1341-T1346, T1349-T1350, shaker)	Ballast (B70-B94, bag)
Foam Sheets (ST1422-ST1427)	Underbrush (FC134-FC139, bag)	2-12mm Static Grass (FS613-FS628)
Track-Bed Rolls (ST1474-ST1476)	Underbrush (FC1634-FC1639, shaker)	Field Grass (FG171-FG174)
Track-Bed Strips (ST1471-ST1473, ST1461-ST1463)	Bushes (FC144-FC149, bag)	
N / HO Scale Tunnel Portals (C1152-C1157 / C1252-C1257)	Bushes (FC1644-FC1649, shaker)	
N / HO Scale Retaining Walls (C1158-C1161 / C1258-C1261)	Realistic Water™ (C1211)	

## Add Profile Boards

You may wish to purchase extra Profile Boards to make taller earth contours for mountains and hills. Run a bead of Low Temp Foam Glue on the bottom of the Profile Board you want to add (be sure your board sits properly for the interlocking features to match up). Set it on top of your constructed profile and push on a connector to join the top and bottom boards (Fig. 92). When you have finished the complete perimeter, trim at the desired height. Don't forget to fill in the corners with 1/2" x 1/2" scrap foam.

**NOTE:** Use scrap Profile Boards for flat areas on your layout. Refer to page 21 for more instructions.

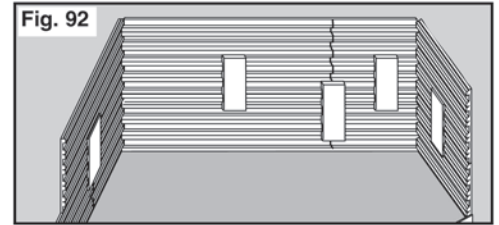

## Add Elevation/Grades

Incline/Decline Sets and Starters are flexible like Risers and allow a smooth transition from one height to another (Fig. 93). With Incline/Declines all the guesswork and calculations are taken out. Simply glue the Incline/Decline on top of Risers to create grades. After installation, cover the Incline/Decline with Plaster Cloth using the instructions in "Add Plaster Cloth To Risers" (page 10). Inclines/Declines are available as Sets (multiple pieces) or Starters (one piece) in 2%, 3% and 4% grades.

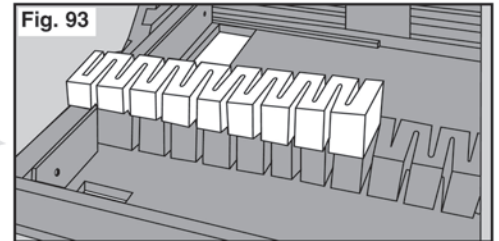
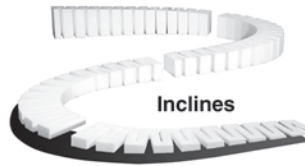

Sets are ideal for grades that grow gradually over a long distance, which is great for a beginner modeler.

- 4% Incline/Decline Set (4 pieces) - Changes elevation from 0" - 4" in 8'
- 3% Incline/Decline Set (6 pieces) - Changes elevation from 0" - 4 1/2" in 12'
- 2% Incline/Decline Set (8 pieces) - Changes elevation from 0" - 4" in 16'

Starters make it easy to form terrain with gently rolling hills, create grades over shorter distances and add inclines for road crossings or ramps.

- 2% Incline/Decline Starters includes 8 identical 2' sections
- 3% Incline/Decline Starters includes 6 identical 2' sections
- 4% Incline/Decline Starters includes 4 identical 2' sections

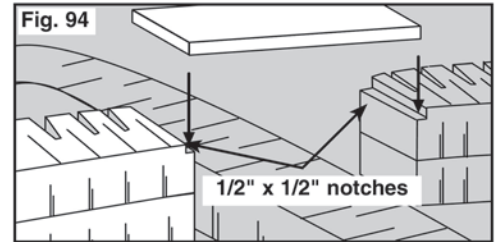

## Overpasses

An overpass can carry your track over a river, pond, road or other train track. If you want to add an overpass, cut 1/2" x 1/2" notches into the tops of the Risers at the overpass. Cut a piece of 1/2" foam to 2 1/2" wide to fit between the notches of the Risers (Fig. 94). Test-fit the overpass, allowing enough room underneath (if you are running a train underneath, leave room for Track-Bed, track and train) then trim, if necessary, to fit flush inside the notches. Glue the overpass in place. Cover the overpass with Plaster Cloth.

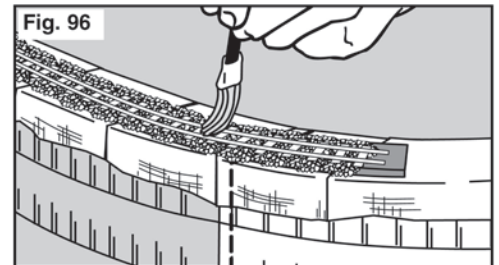
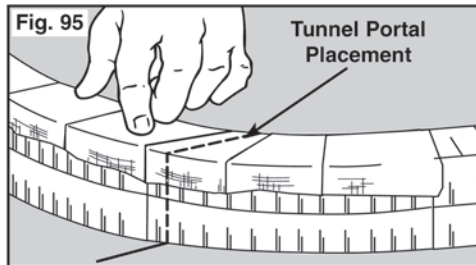

## Tunnels

To make tunnels you will need to use 1/4" Foam Sheets and Tunnel Portals for entrance and exits. After the Plaster Cloth has dried on your Risers, mark where you want your entrance and exit (Fig. 95), then lay your Track-Bed, track and Ballast in that area, extending outward 2" from the entrance and exit (Fig. 96). Test-fit the track and train before making it permanent.

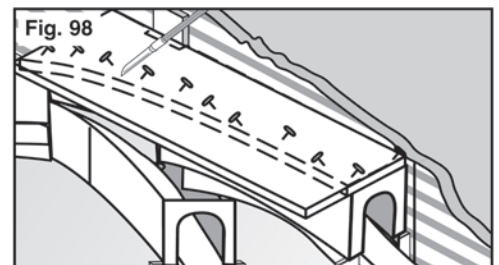
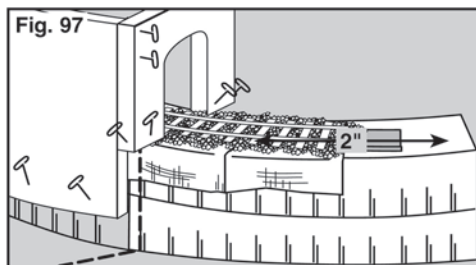



Place the entrance and exit Tunnel Portals where you want them. Use supports (made from scrap foam) so that the ceiling of the tunnel is at least 1/2" to 1" higher than the train. Cut 1/4" Foam Sheets the length of your tunnel and line the Risers on both sides of the tunnel. Glue and pin in place (Fig. 97).

The tunnel roof serves as a support for newspaper wads in a future step. Cut the roof from scrap foam to fit over your tunnel walls (Fig. 98). Make sure your train runs freely through the tunnel. Glue the roof to the tunnel walls with Low Temp Foam Glue.

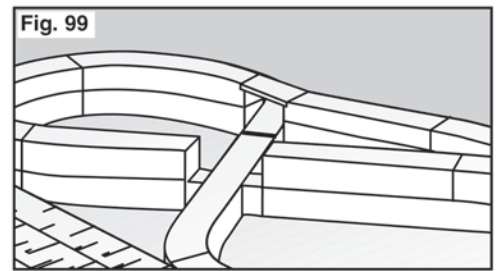

### Bridges

Adding bridges is easy. The bridge is part of the track. Be sure to position the bridge so each end overlaps the tops of the Riser or Incline/Decline by 1/2".

Assemble the bridge on the Riser or Incline/Decline then run a train over it. If it is uneven, sand the Riser or Incline/Decline with 120-grit sandpaper. Remove bridge and set aside until it is time to install your Track-Bed and track. Then, simply install your bridge in line with the track (Fig. 99).

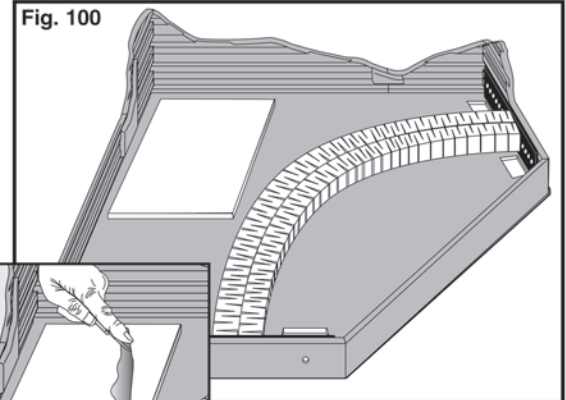
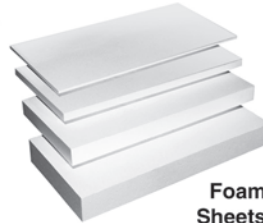

### Make Flat, Level Areas

Foam Sheets or Profile Boards are used to make flat level areas to place buildings, factories or entire towns.

Test-fit the excess foam from the base in the area shown (Fig. 100). You can move or change the flat area to fit your particular design. Normally you would use Foam Sheets for this. But because there is excess foam remaining from the base and Profile Boards, it will be used here to make efficient use of materials.

Trim it to fit the area and set it on the base. Trace around the whole flat area. Cut 10 supports 1 1/2" tall (or as tall as you want) from the scrap Profile Boards. Glue the supports on the traced area (Fig. 101). Then glue the foam piece on top of the supports. After the glue has set, shape ditches and drainage areas with a Foam Knife or hobby knife (Fig. 102).

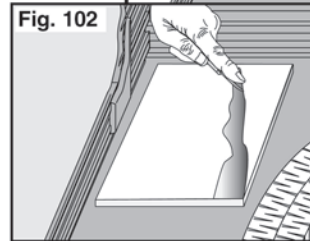
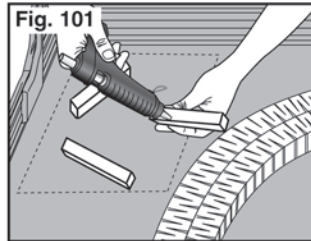

### Add Retaining Walls or Culverts

You may wish to purchase pre-cast Portals, Retaining Walls and Culverts and add them to your layout. These plaster castings can be installed and colored, using the same installation and coloring methods as the rocks. Always test-fit before installing (Fig. 103).

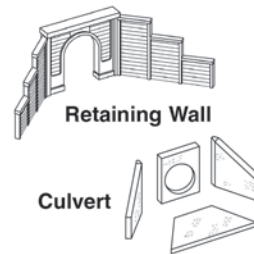

### Connector Plate Set (ST4780)

Each package includes four Connector Plates and six bolts and wing nuts.

Connector Plate Sets allow you to attach the modules in many unique configurations to build the layout of your dreams. Be sure to count the number of Connector Plates needed for your layout (Fig. 104).

Decide where you want to connect your modules together. Set the Connector Plate against the outside of the module and trace around it. Connector Plates should be placed every 18" on center (Fig. 105).

While holding the Connector Plate against the side of the module, choose the three holes you will use. Using a Foam Nail or small nail, poke through the side of the module.

Tip the module up, then draw and cut an Access Hole so you can easily install the Connector Plate inside (Fig. 106). Make sure to allow at least 1" from the edge, so you don't cut the installed Profile Boards.

Clear away the paper from the area. If there is a Riser in the way, don't worry, trim enough to make the Connector Plates fit along the Profile Board (Fig. 107). Just make sure that you have room to easily install three bolts in each Connector Plate.

Test-fit the Connector Plates on the inside by matching the holes on the Connector Plate and the holes poked through the side of the module. Apply Foam Tack Glue or Low Temp Foam

Glue to the rough side of the Connector Plate and press into place. Allow to dry thoroughly. Refer to the "Open Bolt Holes" on page 9.

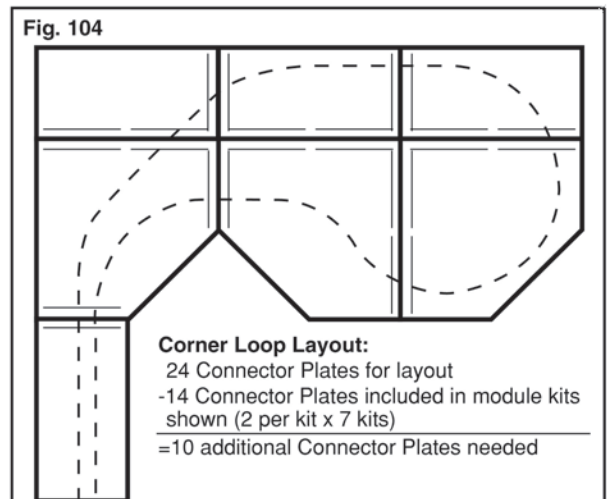
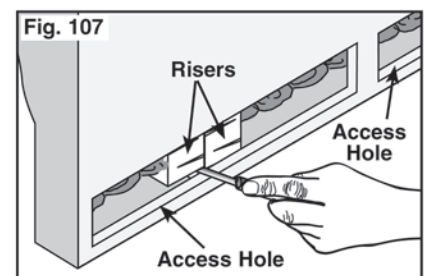
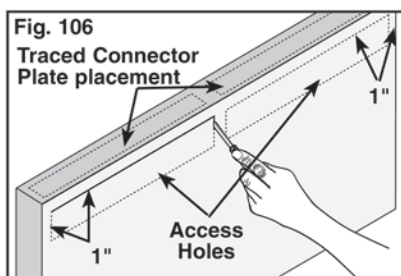
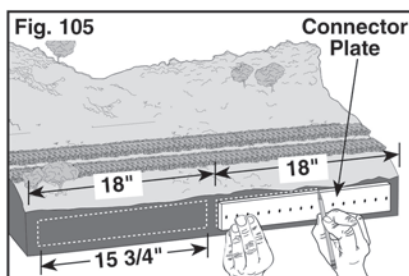

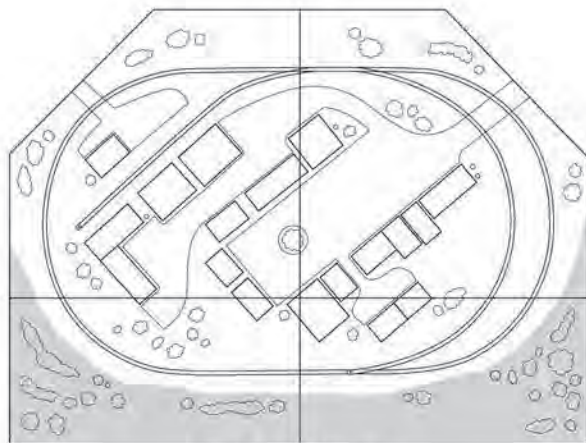

6' x 4 1/2' Layout  
1/2" = 1'

**SHOWN WITH THESE  
ADDITIONAL ITEMS**

- 1.....Top Coat™ Asphalt - ST1453
- 1 .....Top Coat Concrete - ST1454
- 1.....Fine Buff Ballast (bag) - B73
- 1.....Paving Tape™ - ST1455
- 1.....Smooth-It™ - ST1452
- 2.....Connector Plates - ST4780
- DPM® Buildings

**ATLAS SNAP TRACK**

- 5.....9" Straight - At 150
- 17.....Full Section - At 152
- 2.....Customline #4 Switch - At 281
- 1.....Customline #4 Switch - At 282
- 1.....1 1/2 Straight - At 825
- 1.....1/3 18" Radius - At 835
- 1.....1/2 Section 18" Radius - At 834
- 1.....3/4" Straight - At 847a
- 1.....Bumper - At 843

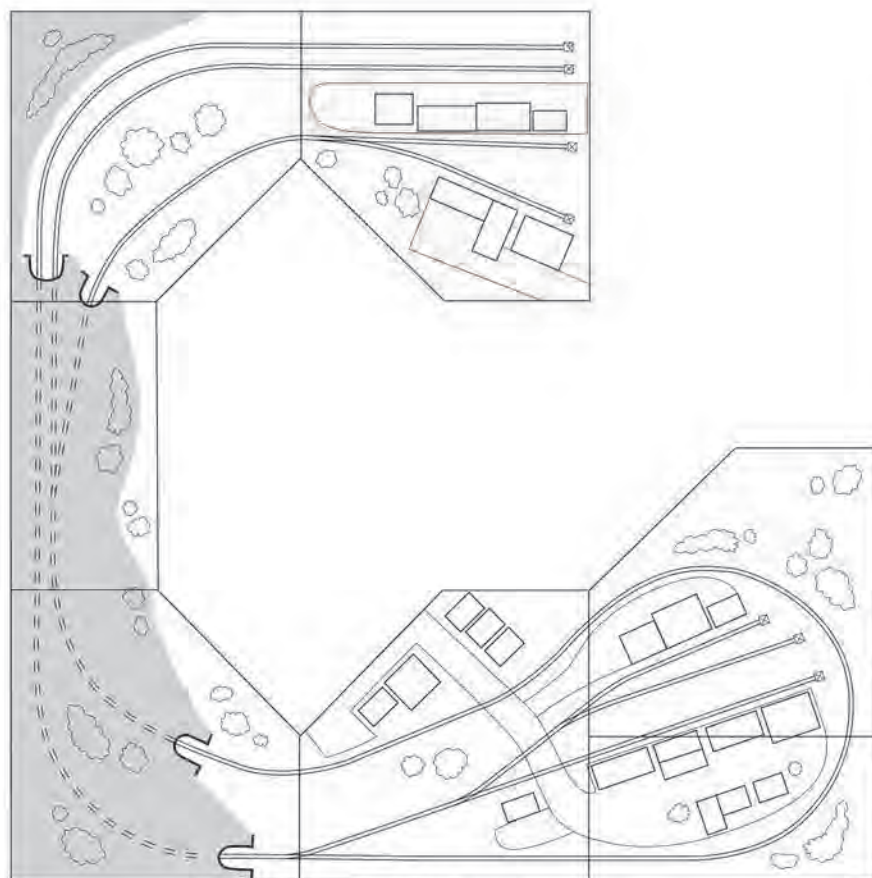

9' x 9' Layout  
1/2" = 1'

**SHOWN WITH THESE  
ADDITIONAL ITEMS**

- 1.....Top Coat Asphalt - ST1453
- 1.....Top Coat Concrete - ST1454
- 11.....2" Risers - ST1408
- 11.....HO Scale Track-Bed - ST1471
- 1.....HO Scale Double Portal
- 2.....HO Scale Single Portal
- 1.....Medium Buff Ballast (bag) - B80
- 1.....Fine Buff Ballast (bag) - B73
- 1.....Realistic Water - C1211
- 1.....Water Effects - C1212
- 1.....Paving Tape - ST1455
- 1.....Smooth-It - ST1452
- 1.....Connector Plates - ST4780
- DPM Buildings

**ATLAS SNAP TRACK**

- 33.....9" Straight - At 150
- 6.....Full Section 18" Radius - At 152
- 2.....Customline #6 Switch, right - At 284
- 5.....6" Straight - At 822
- 23.....22" Radius - At 153
- 1.....3" Straight - At 823
- 1.....1 1/2 Straight - At 825
- 1.....1/2" Section 18" Radius - At 834
- 1.....1/3 18" Radius - At 835
- 1.....2" Straight - At 847e
- 1.....Snap-Switch, right remote - At 851
- 1.....Snap-Switch, left remote - At 850
- 4.....Bumper - At 843



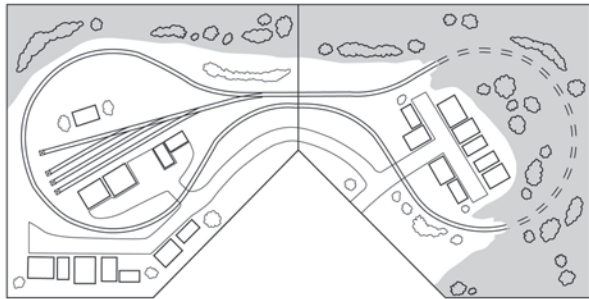

6' x 3' Layout  
1/2" = 1'

**SHOWN WITH THESE  
ADDITIONAL ITEMS**

- 4.....2" Risers - ST1408
- 3.....1/4" Foam Sheet - ST1422
- 4.....N Scale Track-Bed - ST1472
- 1.....Top Coat Asphalt - ST1453
- 1.....Top Coat Concrete - ST1454
- 2.....N Scale Single Portals
- 1.....Fine Buff Ballast (bag) - B73
- 1.....Paving Tape - ST1455
- 1.....Smooth-It - ST1452
- DPM Buildings

**ATLAS SNAP TRACK**

- 13.....5" Straight - At 2501
- 1.....5/8" Straight - At 2509c
- 24.....Full Section 11" Radius - At 2520
- 1.....2 1/2" Straight- At 2509a
- 1.....Standard Turnout Remote Left - At 2700
- 4.....Bumper - At 2536

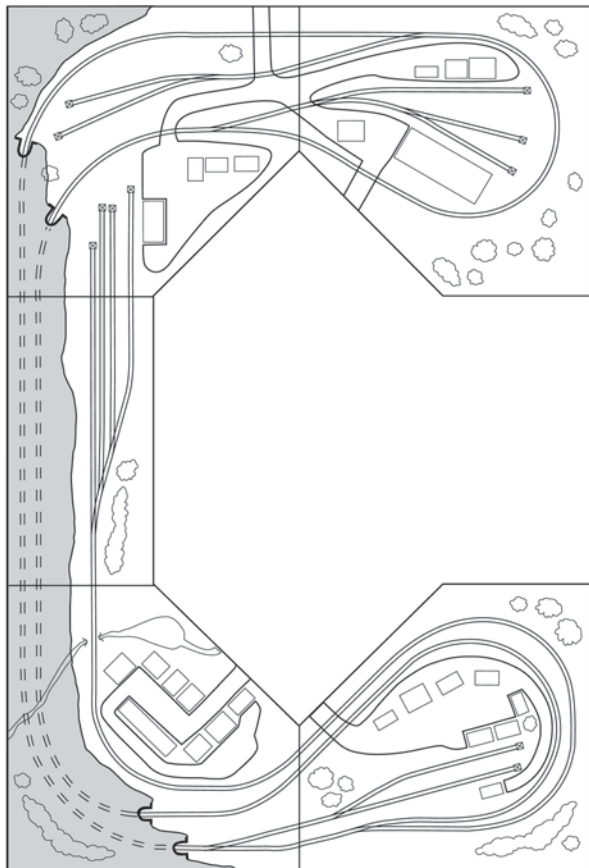

9' x 6' Layout  
1/2" = 1'

**SHOWN WITH THESE  
ADDITIONAL ITEMS**

- 14.....2" Risers ST1408
- 8.....1/4" Foam Sheet ST1422
- 14.....N Scale Track-Bed ST1472
- 1.....Top Coat Asphalt ST1453
- 1.....Top Coat Concrete ST1454
- 4.....N Scale Single Portals
- 2.....N Scale Culverts
- 1.....Fine Buff Ballast (bag) B73
- 1.....Realistic Water C1211
- 1.....Water Effects C1212
- 1.....Paving Tape ST1455
- 1.....Smooth-It ST1452
- DPM Buildings

**ATLAS SNAP TRACK**

- 94.....5" Straight - At 2501
- 5.....1 1/4" Straight - At 2509b
- 3.....5/8" Straight - At 2509c
- 25.....Full Section 11" Radius - At 2520
- 6.....Half Section 11" Radius - At 2521
- 37.....Full Section 19" Radius - At 2526
- 13.....2 1/2 Straight - At 2509a
- 4.....Standard Turnout Remote Right - At 2701
- 6.....Standard Turnout Remote Left - At 2700
- 1.....#6 Turnout Remote Left - At 2704
- 11.....Bumper - At 2536

# Template Usage

## How to Use the Templates

The illustrations below show how to use the turnout and radius templates on page 25.

Radius Templates are used to make curves, depending on scale and railcars you are using. There are other track radius' available. We recommend that you do not make tighter curves than these (**Fig. 108**).

Turnouts are special pieces of track that you can purchase at your local hobby shop. Turnouts are places on your track where you want your train to deviate from the main line: such as railyards, depots, loading docks, etc. The turnout templates (#4, #6 and #8) are three options available to you (**Figs. 108 and 109**).

When laying out an S curve you must place a straight section of track in the middle of the two curves. This is necessary so your train will not derail. It should be at least the length of your longest railcar (**Fig. 108**).

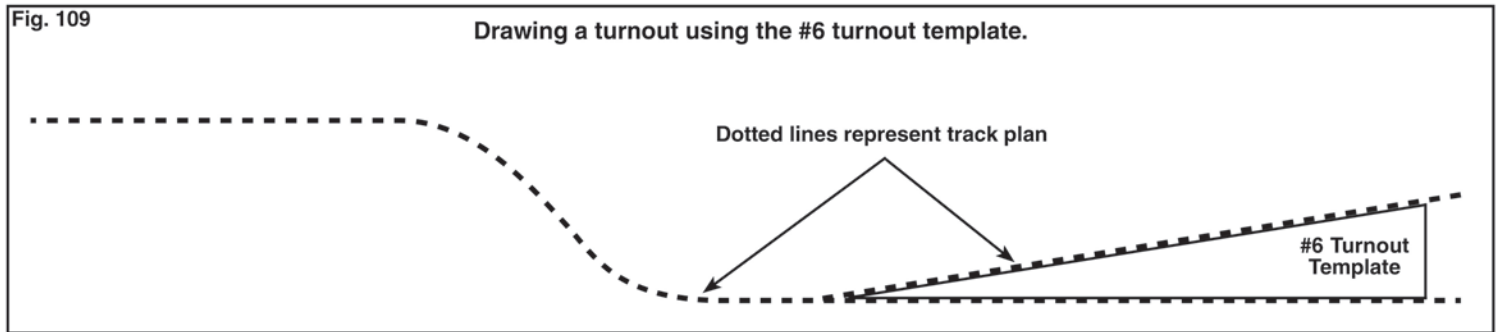
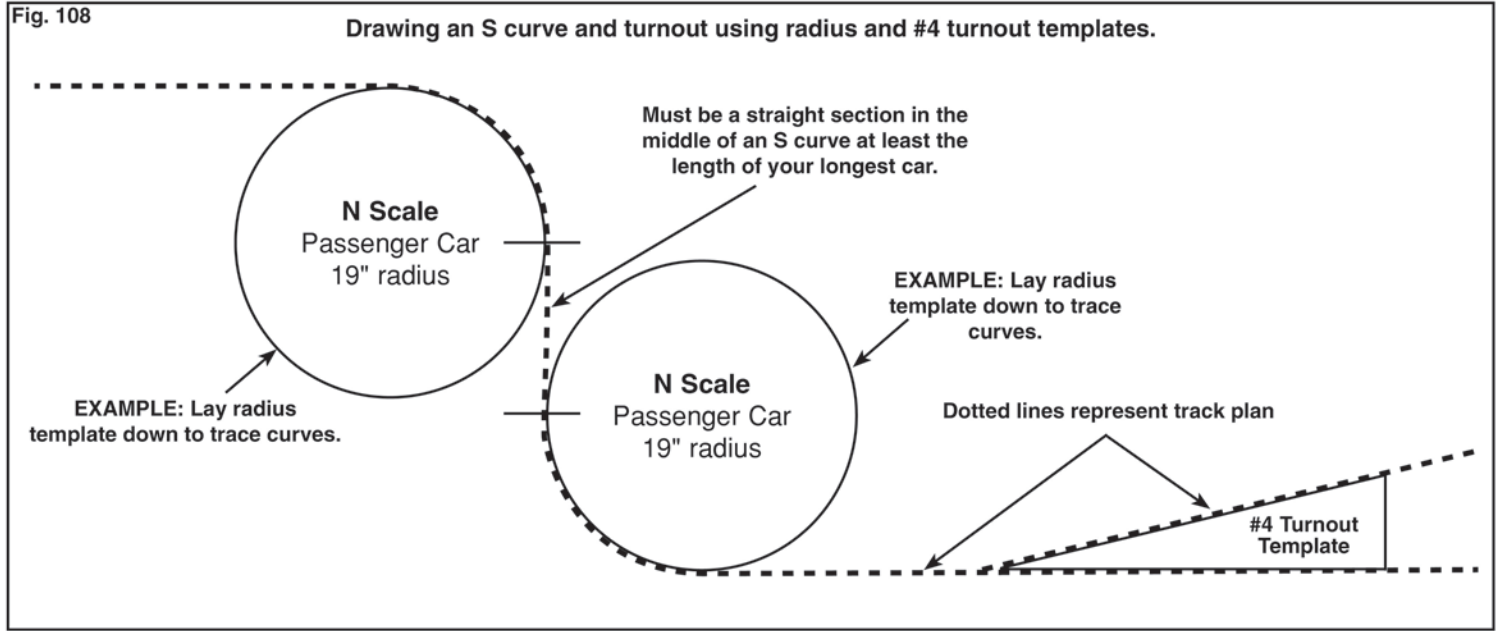

## Add Features

Once your track plan is completed, use colored pencils to create your layout so you can distinguish your tunnels, water areas, bridges and other features.

Now take your layout design to your local hobby shop and they will help you select the right track. Purchase the kits you will need to begin building your dream layout, one module at a time.



# Layout Design Sheet

## Straight Module Patterns 18" x 36"

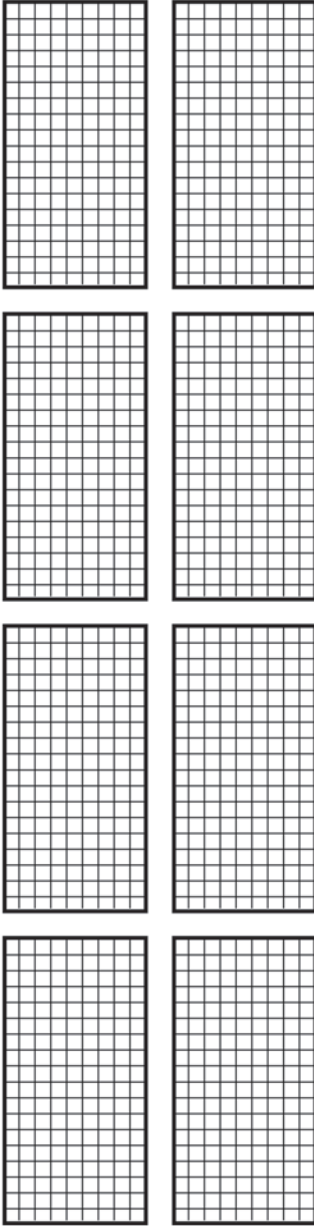

## Corner Module Patterns 36" x 36"

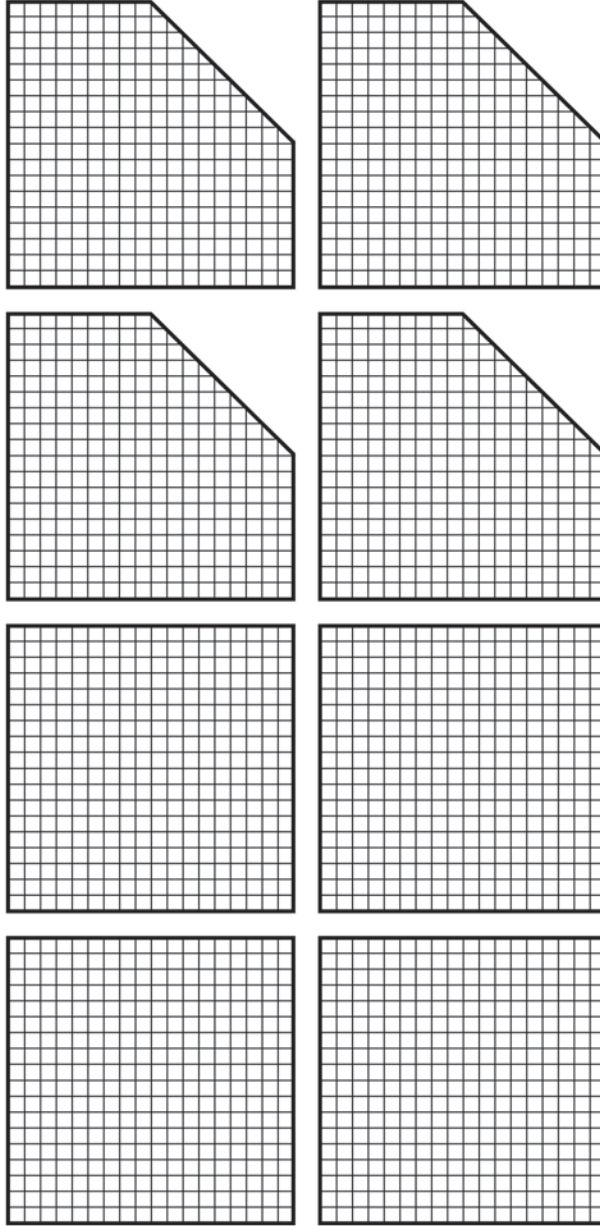

Each square = 2"

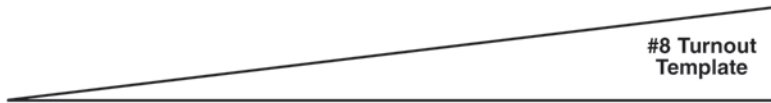
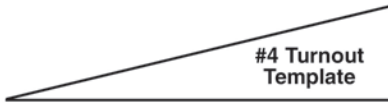

## HO Scale Radius Templates

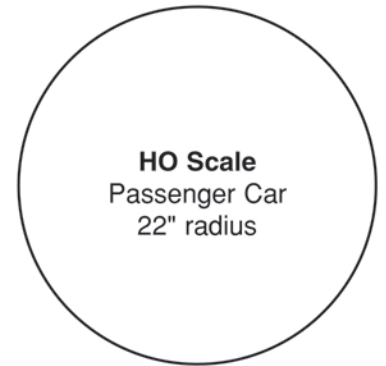
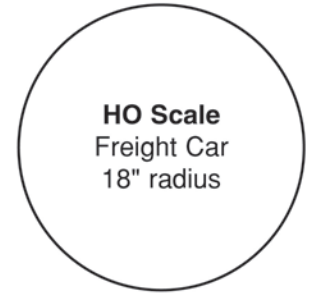

## N Scale Radius Templates

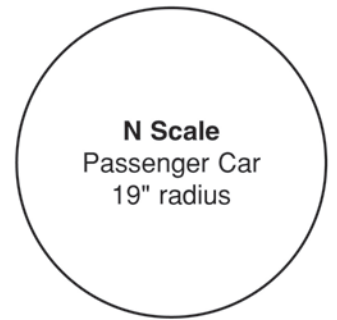

**RULER:** Cut this 8" ruler out to aid you in the design of your track plan.

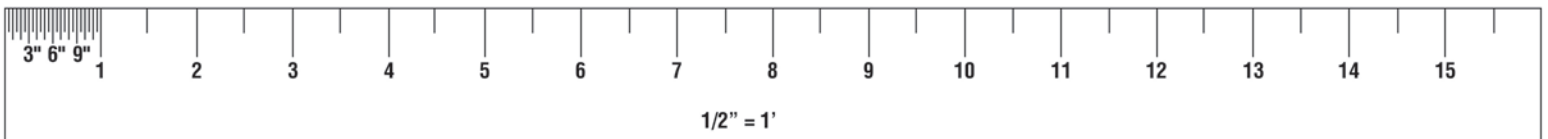

**NOTES:**



GRID: 1/2" = 1'

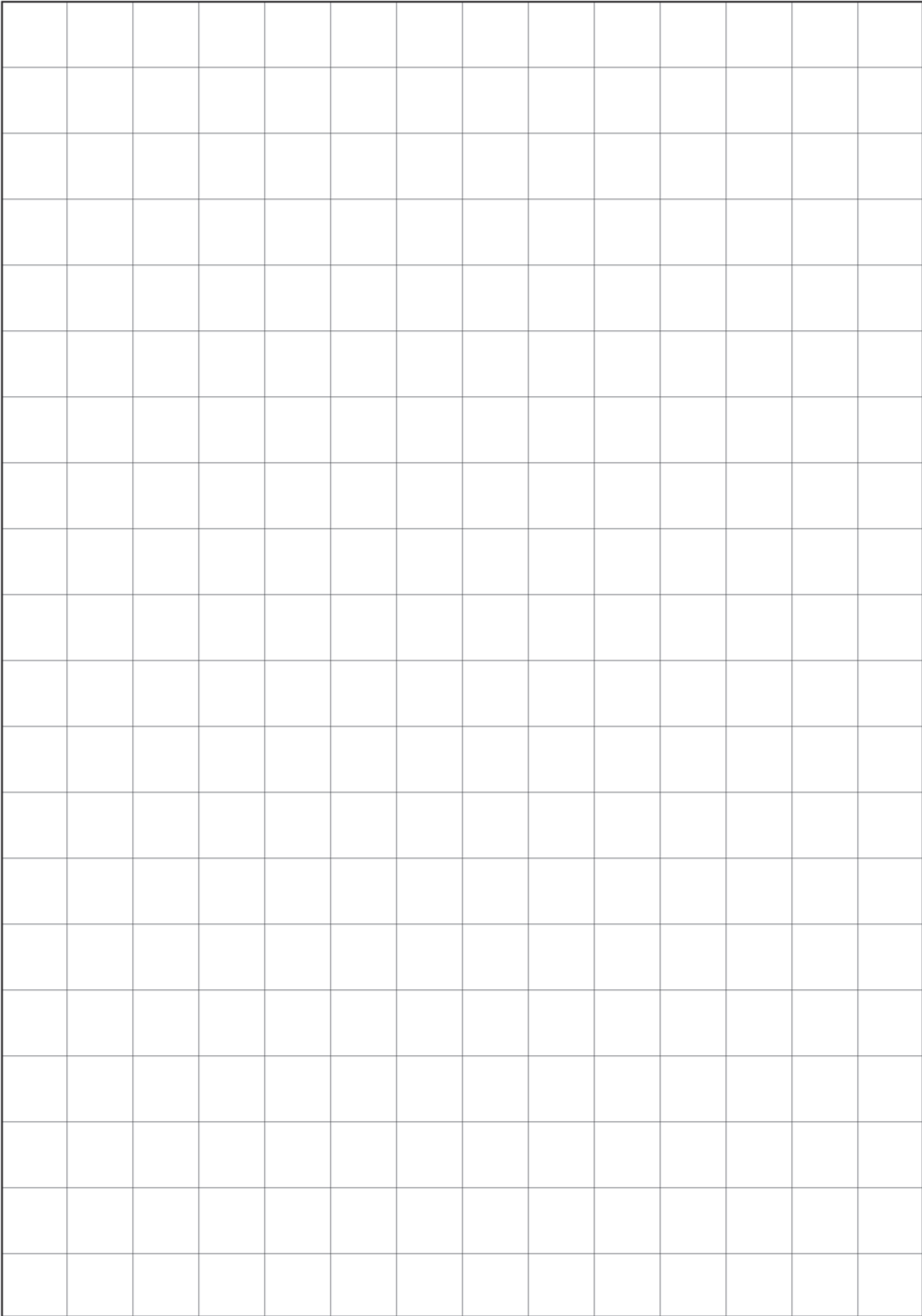

# MOD-U-RAIL<sup>®</sup> SYSTEM

*Build the Layout of Your Dreams ... One Layout at a Time*

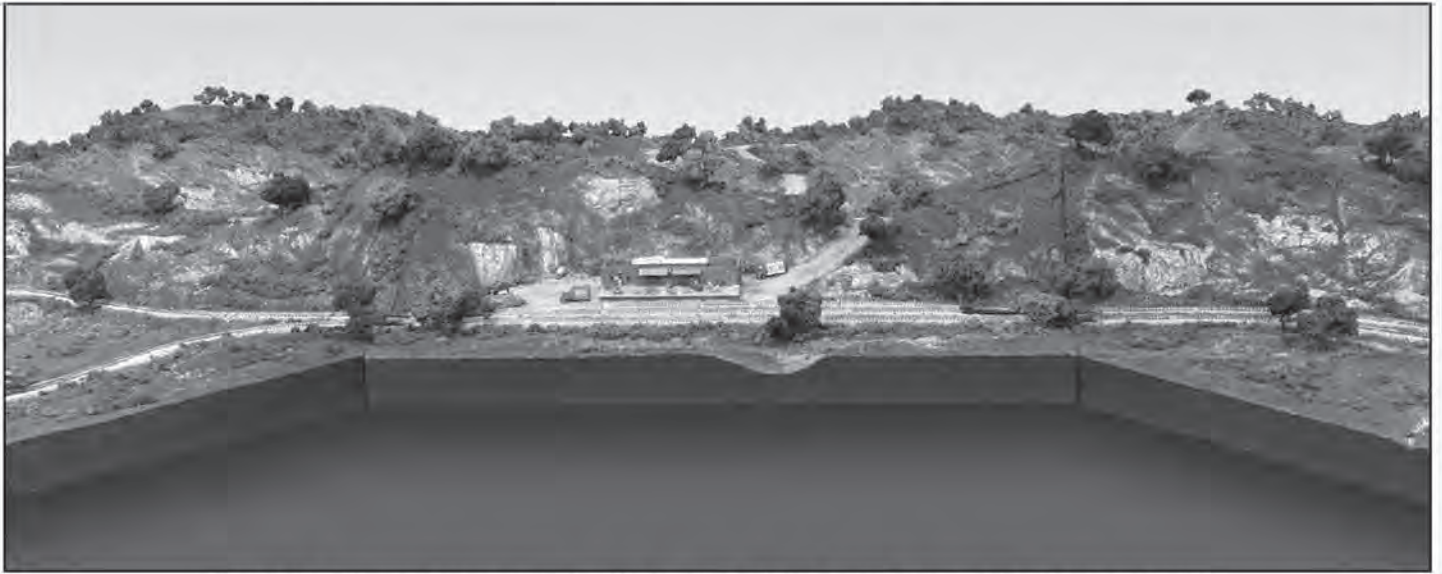

*N scale 9' x 3' layout shown includes (1) Straight and (2) Corners with additional products added.*

## Corner Module Kit (ST4802)

36" x 36" layout

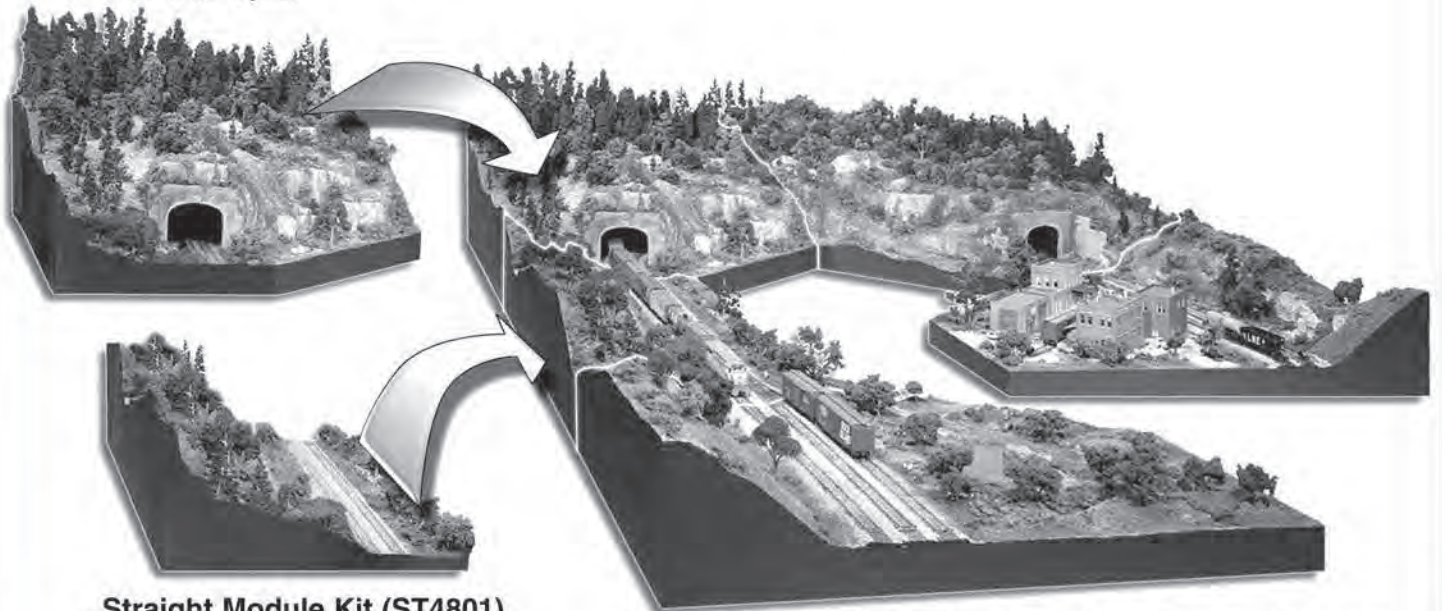

## Straight Module Kit (ST4801)

18" x 36" layout

*HO scale 9' x 6' layout shown includes (1) Straight and (4) Corners with additional products added.*



**WOODLAND SCENICS<sup>®</sup>**  
Manufactured by **WOODLAND<sup>®</sup>**  
P.O. BOX 98 LINN CREEK, MO 65052  
[www.woodlandscenics.com](http://www.woodlandscenics.com)